

LU-mini



Instructions for Use



 This Manual Copyright © 2018 ITL 

All rights reserved. No part of this manual may be reproduced, stored in a retrieval system, or transmitted, by any means or in any form, without the prior permission of Integrated Technologies Limited (ITL).

The information contained in this manual is subject to change without notice. ITL assumes no responsibility for any errors that may appear in this or related documentation.

Document: V501007
Revision: 2-1809

Vitl is the brand name for Integrated Technologies' own range of laboratory products. For further information, please visit the Vitl web site:

www.vitlproducts.com

All sales and technical enquiries should be addressed to:





















UK Vitl Customer Services
Integrated Technologies Limited
Viking House, Ellingham Way, Ashford, Kent, TN23 6NF
United Kingdom
+44 (0)1233 638383
sales@vitlproducts.com

USA ITL Virginia Inc.
305 Ashcake Road, Suite L, Ashland, Virginia 23005
USA
+1 804-381-0905
sales@vitlproducts.com

CHINA Integrated Electronic Systems (Shanghai) Co Ltd
T3-11 Unit 201, No. 5001 Hua Dong Road, Pudong,
Shanghai 201201, China
+86 (0)21 585 854 63
sales@vitlproducts.com

Contents

1	☉ Symbols Used in this Instruction Manual	6
2	☉ Safety Precautions and Limitations of Use.....	7
3	☉ Regulatory Limitations of Use	11
4	☉ Lu-mini Unit Description	12
4.1	☉ Acceptable Sample Vessel Types and Fill Volumes.....	15
5	☉ Lu-mini Unit Installation.....	16
6	☉ Basic Unit Operation.....	17
6.1	☉ User Display and Controls.....	17
6.2	☉ Powering-up the Lu-mini Unit	20
6.3	☉ Selecting the Active User	22
6.4	☉ Selecting a Protocol and Performing a Reading	24
6.4.1	☉ Selecting a Protocol	24
6.4.2	☉ Editing the Sample ID.....	25
6.4.3	☉ Sample Vessel Insertion and Removal	27
6.4.4	☉ Performing a Reading	28
6.4.5	☉ Results Status Tagging and Adding a Comment Note	30
6.5	☉ Viewing the Test Results Database	33
6.5.1	☉ Deleting Test Results from the Lu-mini Database	34
6.6	☉ Using the Timer Function	35
6.6.1	☉ Using an Independent Timer	36
6.6.2	☉ Using Linked Cascading Timers.....	38
6.6.2.1	☉ Linking Timers into a Single Cascading Group	38
6.6.2.2	☉ Linking Timers into Multiple Cascading Groups.....	40
6.6.3	☉ Using the Timers whilst Sample Testing	40
6.7	☉ Unit Set-up Options	41
6.7.1	☉ Setting the Clock and Date/Time Formats	43
6.7.2	☉ Beeper and Button Click Volume	43
6.7.3	☉ Remembering the Last Active User ID	44
6.7.4	☉ Define Automatic Sample ID Text Format.....	44
6.7.5	☉ Reader Test Mode.....	45
6.8	☉ Standby Mode and Unit Shutdown Procedure.....	46
7	☉ Lu-mini Windows App and Advanced Unit Configuration.....	48
7.1	☉ Installing the Lu-mini Windows App and USB Driver	48
7.2	☉ Lu-mini App Basic Functionality	50
7.2.1	☉ Page Selection Buttons	51
7.2.2	☉ Toolbar Options.....	52
7.2.3	☉ Help Menu Options.....	52
7.2.4	☉ Data Table Field Editing and Context Menu.....	53
7.3	☉ Data Synchronisation	56
7.4	☉ Test Results Database Page.....	57
7.4.1	☉ Uploading Results Data.....	58
7.4.2	☉ Exporting Test Results Data.....	58
7.4.3	☉ Deleting Results Data.....	58
7.5	☉ User IDs Page	59

7.6		Global Unit Settings Page.....	60
7.6.1		Adding a New Unit	61
7.7		Sample Measurement Protocols Page.....	61
7.7.1		Protocol Name and Reagent Assay	63
7.7.2		Sample Method Types	63
7.7.2.1		Single Tube Measurements	64
7.7.2.2		Multiple Tube Measurements.....	64
7.7.2.3		Continuing a Multi-Tube Test from the Worklist.....	66
7.7.3		Measurement Types.....	67
7.7.4		Test Result Options and Banding.....	68
7.8		Reagent Assays Page.....	71
8		Troubleshooting.....	74
9		Maintenance and Servicing	76
9.1		Routine Cleaning and Inspection	76
9.2		Decontamination Procedure.....	78
9.3		Transportation and Storage.....	79
9.4		Product Disposal	79
10		Warranty and Returns	80
11		Technical Specification	81
12		Glossary of Terms and Abbreviations	83



WARNING

Please ensure that you have read and fully understood the **Safety Precautions and Limitations of Use** in Section 2 of this manual before attempting to install or operate this product.









Failure to do so could result in severe injury or may damage the unit and invalidate the product warranty.

 **Tables** 

Table 1: Advisory Symbol Meanings	6
Table 2: Unit Features	13
Table 3: Unit Accessories	14
Table 4: Acceptable Sample Vessel Types	15
Table 5: Main Menu Button Functions	17
Table 6: Navigation Button Functions	18
Table 7: Status and Prompt Symbols	19
Table 8: Result Status Tag Symbols	31
Table 9: Timer Function Buttons and Status Symbols	35
Table 10: User Preferences and Options	42
Table 11: Automatic Sample ID Buttons	44
Table 12: Lu-mini App Page Select Buttons	51
Table 13: Lu-mini App Toolbar Options	52
Table 14: Lu-mini App Help Menu Options	52
Table 15: Data Cell Context Menu Options	55
Table 16: Test Results Database Data Fields	57
Table 17: User IDs Data Fields	59
Table 18: Unit Settings Data Fields	60
Table 19: Time and Date Synchronisation Options	60
Table 20: Protocols Table Data Fields	62
Table 21: Sample Method Options	64
Table 22: Sample Measurement Types	68
Table 23: Reagent Assay Data Fields	72
Table 24: Troubleshooting Suggestions	74
Table 25: Lu-mini Unit Error Codes	75

1 Symbols Used in this Instruction Manual

The following advisory symbols are used in this manual.

Table 1: Advisory Symbol Meanings	
 DANGER	Indicates a Risk of Electric Shock which could, if not avoided, result in severe injury or death.
 DANGER	Indicates a Risk of Explosion which could, if not avoided, result in severe injury or death.
 WARNING	Indicates a hazardous situation which could, if not avoided, result in severe injury or death; or severely damage the unit.
 CAUTION	Indicates a hazardous situation which could, if not avoided, result in minor or moderate injury; or degrade or impair the functionality of the unit.
 CAUTION	Indicates an Electrostatic-Sensitive Device for which care should be taken not to touch the exposed electrical contacts as this could degrade or impair the functionality of the unit.
 CAUTION	Indicates a possible crush hazard due to moving parts which could, if not avoided, result in minor or moderate injury.
	Advisory or other useful information.
	Refer to Lu-mini App advanced set-up features
	Refer to “Section NN” for more details.

2 Safety Precautions and Limitations of Use

It is essential that all users of this equipment have fully read and understood the following safety precautions and limitations of use before installing or operating the Lu-mini unit.

IMPORTANT



WARNING

The protection provided by this equipment may be impaired if it is not used in a manner described in this manual.



WARNING

It is essential that the user of this equipment is aware of the potential hazards associated with the unit and its accessories.

All operators should be familiar with the safety precautions and warnings given in these instructions before attempting to operate the unit.

Improper use of this unit or its accessories may impair their functionality and invalidate the manufacturer's warranty.

Unit Handling Precautions



CAUTION

Care should be taken not to drop the unit or subject it to rough physical handling, both during normal use and during installation, transportation and storage.

Do not use the unit if it shows any signs of damage or wear.



WARNING

The unit should be held and supported in both hands when lifting or moving. Do not lift the unit by the lid.

Care should be taken to avoid trapping fingers under the unit when placing it down on a solid surface.



CAUTION

Care should be taken not to knock the LCD display.

Do not use excessive force when pressing the touchscreen buttons or when cleaning it.

Unit Installation and Operating Environment



DANGER

The Lu-mini unit is designed for indoor laboratory use only.

The acceptable operating temperature range is 18°C to 38°C, with a relative humidity of 20% to 85% non-condensing, at a maximum altitude of 2000m above sea level.



WARNING

If the unit is stored in conditions outside of these ranges, it must be left to stand unpowered until it has acclimatised to within these environmental limits before being powered.

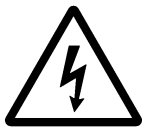

DANGER

Use the USB power adaptor provided with the unit.

Care should be taken when powering the unit from a computer USB port or alternative USB power source.



WARNING

Always ensure that the USB power cord is securely inserted into the rear of the unit.

Ensure that any excess power cord does not pose a potential trip or pull hazard.



DANGER

Do not operate the unit in any area which is, or has been, or is thought to have been exposed to explosive or flammable gases, vapours or liquids.



WARNING

The unit must be installed and operated on a solid, stable, vibration-free and level working surface.



CAUTION

For best results, the unit should be installed and operated in a stable thermal environment, out of direct sunlight and away from sources of heat or draught.

General Operating Precautions

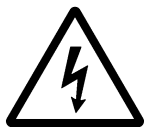

DANGER

Ensure that the power is switched off at the mains outlet before inserting or removing the USB power cord.

If a spillage occurs in or over the unit, switch the power off and unplug the USB cord at the power adaptor before attempting to deal with the spill.



DANGER

The unit is intended for use with aqueous solutions only.

Never use the unit with any explosive, volatile or highly reactive substances or chemicals.



WARNING

To avoid liquid spills and possible cross-contamination of samples, use sealed or capped tubes of the type specified in Section 4.1.

Always follow prescribed laboratory procedures and use appropriate personal protective equipment (PPE - such as gloves, clothing, goggles, etc.) when handling samples.



CAUTION

The unit lid poses a possible finger crush hazard.

Take care when opening and closing the lid to ensure hands, fingers and protective gloves do not get trapped.

Do not insert your finger into the reader sample chamber.



CAUTION

The unit lid catch contains a small magnet. Avoid direct contact with any magnetic-sensitive devices or assays.



CAUTION

Avoid touching the contacts of the USB port on the rear of the unit as an Electrostatic Discharge (ESD) could degrade or impair the functionality of the unit.

Unit Maintenance and Serviceability



WARNING

There are no user or operator serviceable parts inside the unit.

Do not remove the unit casework. Removal of the unit's casework will void the manufacturer's warranty.

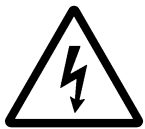

DANGER

Always disconnect the USB power cord from the unit before performing any cleaning or decontamination procedure.

If liquid is spilt into or over the unit, switch off and disconnect the USB from the source before attempting to deal with the spillage.



CAUTION

The use of harsh chemicals and cleaning agents may damage the unit and degrade its performance.

Always follow the cleaning and decontamination procedures specified in Sections 9.1 and 9.2 of this instruction manual.

3 Regulatory Limitations of Use

Declaration of Conformity

Integrated Technologies Limited (ITL) affirm that this product fulfils the essential requirements of the Low Voltage Directive 2014/35/EU and the EMC Directive 2014/30/EU, when installed and operated in accordance with the instructions in this manual.



ELECTRICAL SAFETY
E113628

Safety Standards

- EN 61010-1:2010,
- EN 61010-2-010:2003
- UL 61010-1:2001 3rd Edition (CAN C22.2 CSA 61010-1)
- MET Labs NRTL Electrical Safety – Listing No E113628

EMC Standards

- EN 61326:2013, Class A
- FCC CFR 47 Parts 15.107 and 15.109, Class A

RoHS and WEEE Directive Compliance



This product complies with the requirements of the RoHS2 Directive 2011/65/EU for Electrical and Electronic Equipment and in accordance with BSEN 50581:2012.

Where applicable, the Lu-mini unit should be disposed of in accordance with the European Union WEEE Directive 2002/96/EC on Waste Electrical and Electronic Equipment.

Do not dispose of this product into unsorted municipal waste or public landfill. Please refer to Section 9.4 for details of how to correctly dispose of this product.

The Lu-mini unit is designed and manufactured under ISO 9001 by:

Integrated Technologies Limited

Viking House, Ellingham Way, Ashford, Kent, TN23 6NF
United Kingdom

4 Lu-mini Unit Description

The Lu-mini unit is a benchtop Luminometer and has the following external features:

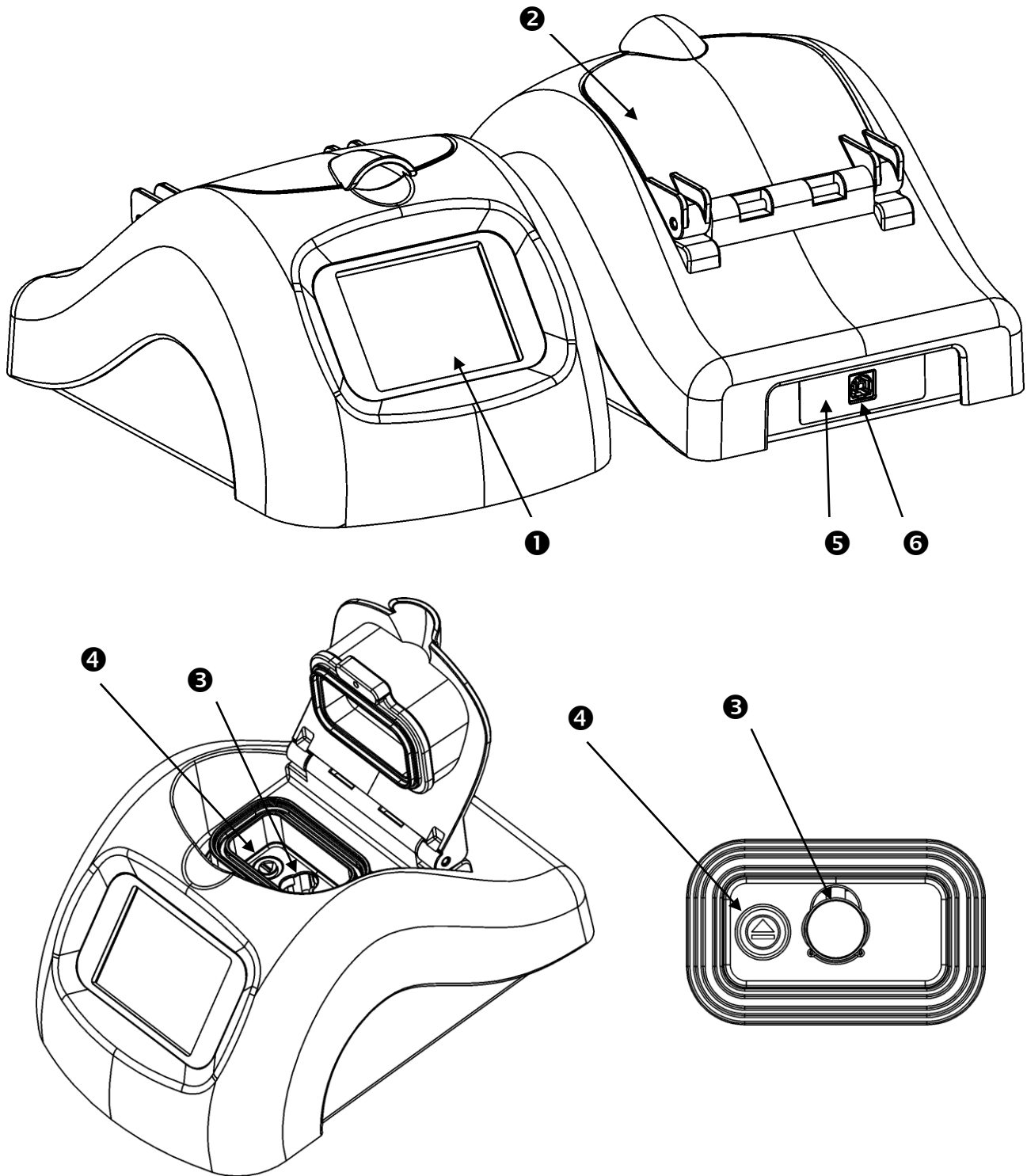
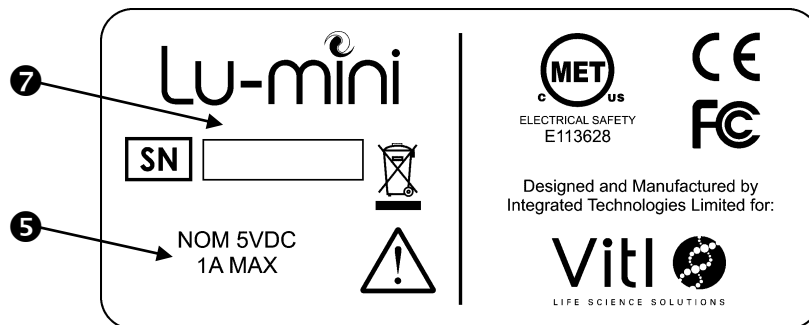
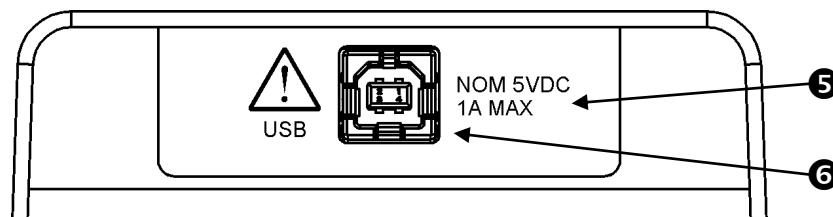

Table 2: Unit Features		
①	LCD Touchscreen User Interface	⇒ 6.1
②	Unit Lid	⇒ 6.4
③	Reader Sample Chamber	⇒ 4.1
④	Sample Vessel Eject Button	⇒ 6.4.3
⑤	Power Rating	⇒ 11
⑥	USB Power Inlet	⇒ 0
⑦	Unit Label and Serial Number	⇒ 0



The unit label is located on the underside of the unit and provides the unit serial number, voltage and power ratings:



There is also a label surrounding the USB Power Inlet at the rear of the unit which provides the voltage and power ratings:



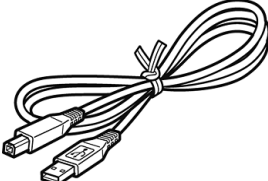

The unit is supplied with the following accessories:

Table 3: Unit Accessories		
	<p>AC/DC USB Power Adaptor</p>	<p>⇒ 6.2</p>
	<p>USB Power Cable</p>	<p>⇒ 6.2 ⇒ 11</p>
	<p>Lu-mini App Install Flash Drive</p>	<p>⇒ 7</p>

4.1 Acceptable Sample Vessel Types and Fill Volumes

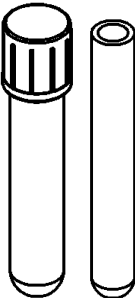
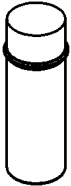
The Lu-mini unit is designed to accept the following sample vessel types.

Table 4: Acceptable Sample Vessel Types		
Vessel Type	Vessels Sizes	Sample Volumes
Tube 	Round round-bottomed 10mm to 12mm diameter 47mm [#] to 75mm* tall * Including cap	10mm 12mm Recommended: 500uL 800uL Minimum: 200uL 300uL
Vial 	Round flat-bottomed 15mm diameter 48mm [#] tall	15mm Recommended: 1500uL Minimum: 600uL
Cuvette 	Square flat-bottomed 12.5mm square 48mm [#] tall 10mm path length	12.5mm Recommended: 1000uL Minimum: 500uL

The recommended tube type is the 12mm x 75mm (5mL) round-bottomed polypropylene test tube with a screw cap. Such as:

- Universal Medical Inc - GS-6148R or GS-6148W
- Corning Life Sciences - Falcon 352003 or 352058



CAUTION

To avoid liquid spills and possible cross-contamination of samples, use sealed or capped tubes whenever possible.

[#] Note: Refer to Section 6.4.3 for specific details on how to insert and remove the sample vessels from the Reader Sample Chamber – particularly for sample vessels with a height of less than 50mm.

5 Lu-mini Unit Installation

Before installing the Lu-mini unit, please check that the delivery is complete (see Table 3) and that the unit and all accessory parts are intact and free from any signs of transportation damage. Also ensure that all external and internal packaging has been removed from the unit before installation.



Please retain all packaging for future transportation and storage of the unit and its accessories.

The Lu-mini unit should be installed in a location which meets the following requirements:

- Safe and suitable operating environment (see Section 2)
- Solid, stable, vibration-free and level working surface
- At least 10cm clearance around the unit to adjacent objects and walls
- Out of direct sunlight and away from sources of heat or draught



WARNING

Please also observe and abide by the **Unit Installation and Operating Environment** safety precautions and preconditions listed in Section 2 of this manual.

When the unit is initially installed, the real-time clock will need to set to your local time and date. Please read Section 6 first, and then refer to Section 6.7.1 for details.



NOTE

When the unit is initially powered, or if the unit has been in storage or left unpowered for several months, the internal real-time clock battery will need recharging.

The unit may report an **E85** warning (see Section 8).

Please leave the unit powered for at least 2 hours (preferably 8 hours) to recharge the battery.



Please refer to Section 7.1 for details on installing the associated Lu-mini Windows App.

6 Basic Unit Operation



WARNING





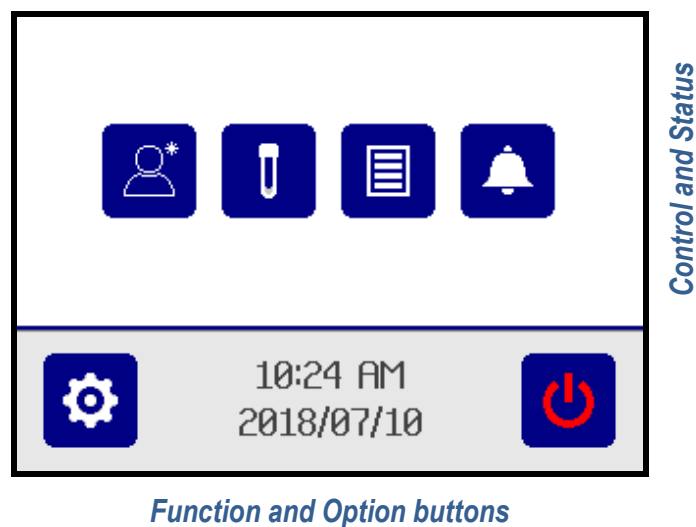

Please ensure that you have read and fully understood all of the **Safety Precautions and Limitations of Use** listed in Section 2 before attempting to operate the Lu-mini unit.

6.1 User Display and Controls











The unit's user interface consists of a colour LCD touch screen display. The menu structure is divided into two main sections as shown below.



The above screen shows the **Main Menu** buttons, which provide the following functionality.







Table 5: Main Menu Button Functions		
	Select active User ID (Any User / Specific User)	⇒ 6.3
	Select Protocol and perform Reading	⇒ 6.4
	View the Test Results Database	⇒ 6.5
	Enter Timer function	⇒ 6.6
	Enter unit Set-up options menu	⇒ 6.7
	Unit Standby and Wakeup modes	⇒ 6.8

Below is a list of other menu and data list navigation buttons and their functions.

Table 6: Navigation Button Functions		
	Accept or Cancel option	⇒ 6.7
	Return to Main Menu	⇒ 6.1
	Return to Previous menu	⇒ 6.4
	Edit Sample ID	⇒ 6.4
	Expand database result	⇒ 6.5
	Test result Status tag	⇒ 6.4.5
	Test result Comment	⇒ 6.4.5
	Jump to Top or Bottom of data list	⇒ 6.5
	Move Up and Down data list or Increase and Decrease value	⇒ 6.5
	Move to Next value	⇒ 6.7

Other function-specific button icons are explained in Sections 6.3 to 6.8.

There are also various status and prompt symbols that may appear in the main screen area, as detailed in Table 7 below.

Table 7: Status and Prompt Symbols		
	Prompt: Open Lid	⇒ 6.4.3
	Prompt: Insert Sample vessel	⇒ 6.4.3
	Prompt: Use specified Tube Number	⇒ 6.4.3
	Status: Sample Inserted correctly	⇒ 6.4.3
	Prompt: Close Lid	⇒ 6.4.3
	Prompt: Remove Sample vessel	⇒ 6.4.3

When the lid is open, the unit also periodically beeps to prompt the user to close the lid as soon as possible.



For optimum reader performance, the lid should always be kept closed when not inserting or removing a sample vessel.



Please refer to Section 7 for additional buttons and symbols which relate to specific Lu-mini App features.

6.2 Powering-up the Lu-mini Unit

The Lu-mini unit is powered via a standard USB cable, from the supplied AC/DC USB Power Adaptor. However, it can also be powered from a USB port on a desktop or laptop computer, a USB battery pack or a 12V to USB Car Charger.



Plug the supplied USB Cable into the Lu-mini Unit and then into the power source, and (if necessary) switch on the power source.

The Lu-mini unit LCD will light-up and display the power-up progress screen whilst the internal data memory is checked and the reader initialised.

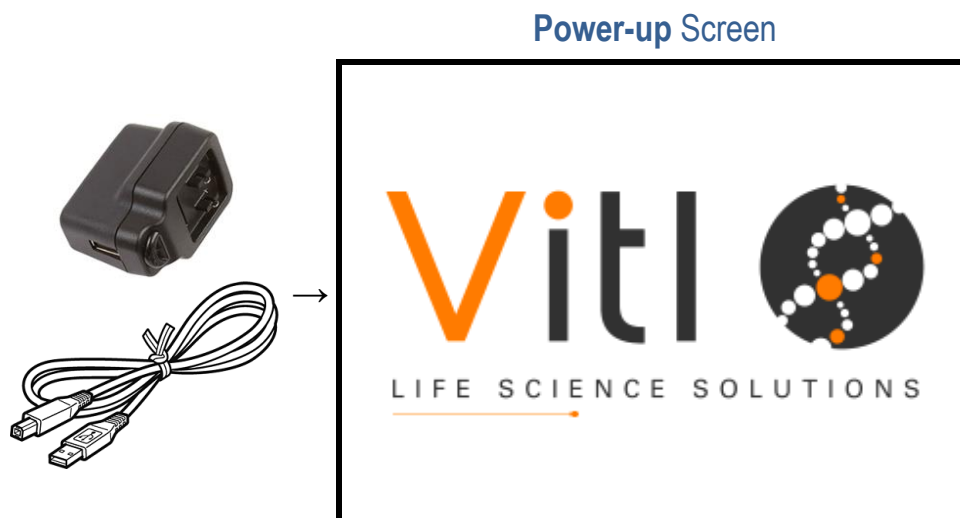

Following this the **Main Menu** screen is displayed.

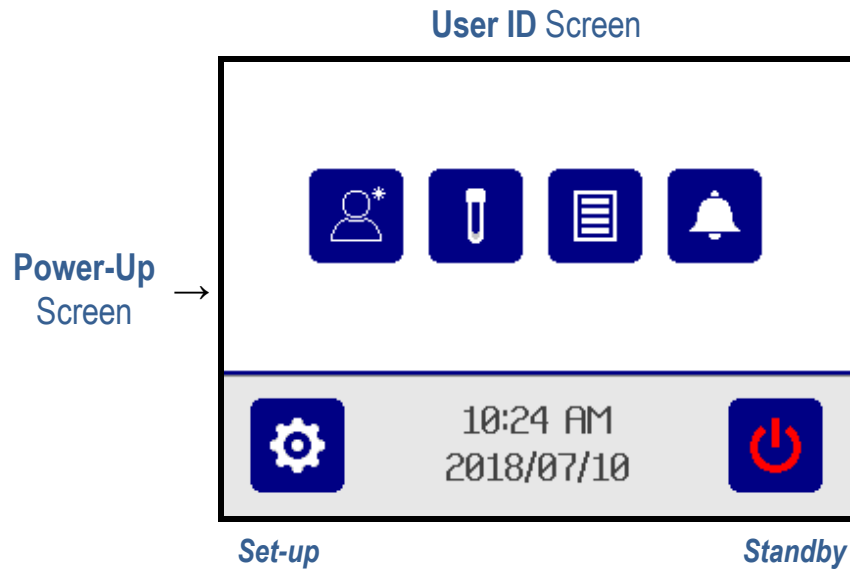

The current time and date are displayed on the **Main Menu** screen as a visual check that there are correctly set. This is important as the time and date are required for the **Reading** and **Timer** options to function correctly.

Note: If the unit clock is not set, the time and date are displayed in **red** and the **Reading** and **Timer** options are disabled until the clock is set.



To set the clock, press the **Set-up** options button followed by the **Date/Time** button. See Section 6.7.1 for more details.

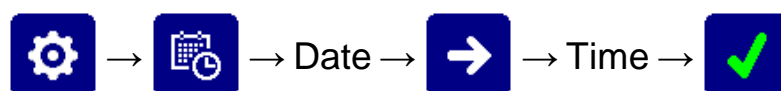

6.3 Selecting the Active User

The **User ID** function allows the current active user of the unit to log all the test results they perform against their own personal User ID. To change the User ID, press the **User ID** button from the **Main Menu**.

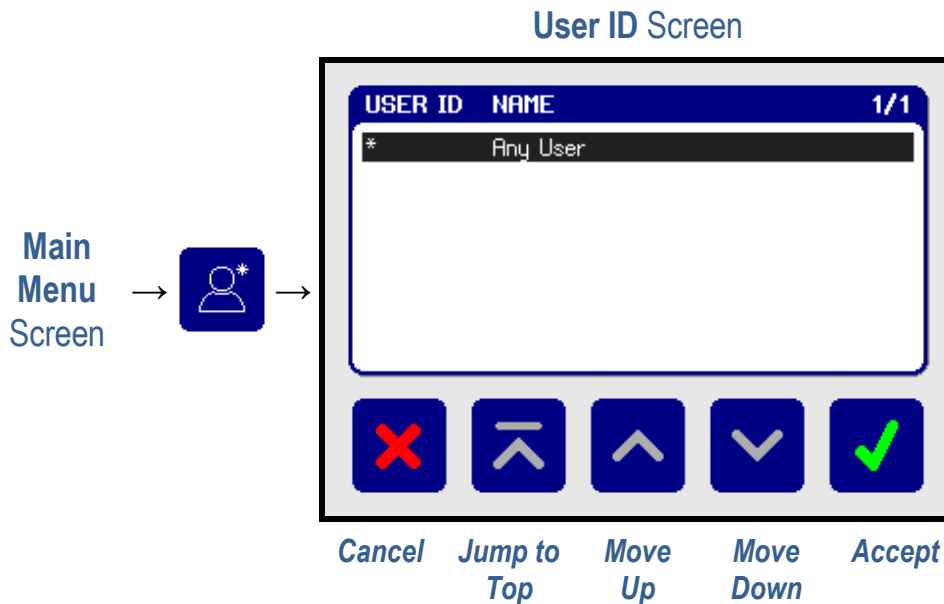

By default, the **User ID** is set to **Any User** and there are no other User IDs available to choose from, therefore the **Up** and **Down** arrow buttons are disabled. To return to the main menu press the **Accept** or **Cancel** button.



Additional User IDs can only be added and edited via the Lu-mini Windows Application. See Section 7.5 for details.

When additional User IDs have been downloaded to the unit, the **Up** and **Down** buttons will be enabled to allow the desired User ID to be selected from the list.

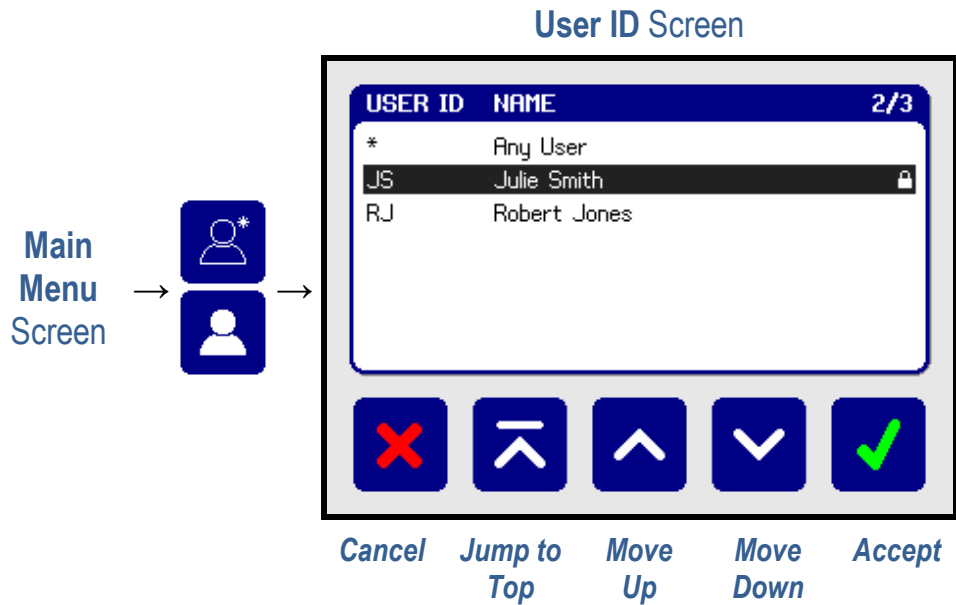

The **Padlock** symbol (🔒) on the right indicates that the User ID is password protected (see Section 7.5). When selected, the QWERTY keyboard is displayed to allow the password to be entered.

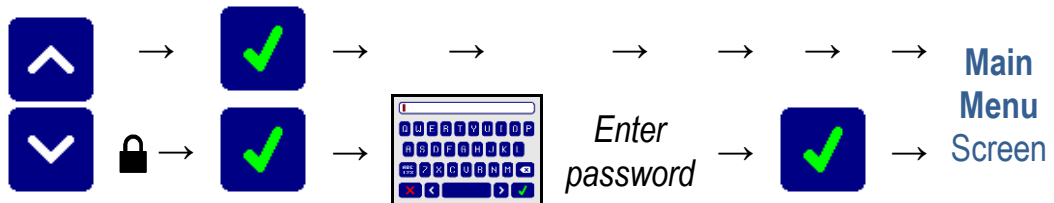

The **User ID** and **User Name** are displayed on the Main Menu screen, and the User ID button changes to a solid figure indicating a specific User ID is active.

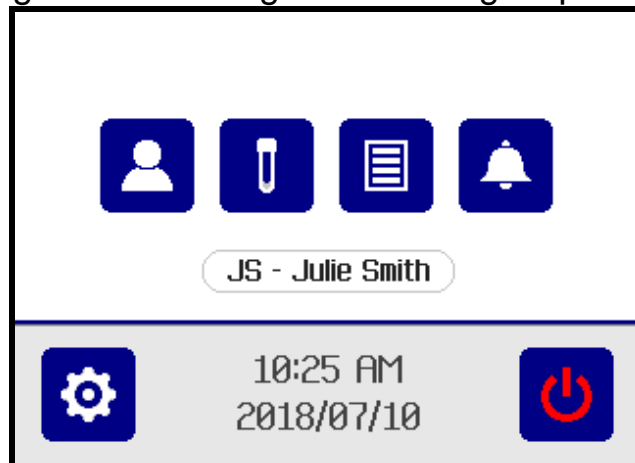

By default, the unit remembers the most recently selected User ID and automatically selects this user when the unit is next powered up. To change this behaviour, refer to Section 6.7.3.

6.4 Selecting a Protocol and Performing a Reading

Once the **User ID** has been checked and set, the sample measurement **Protocol** can be selected so that a sample test can be performed.

6.4.1 Selecting a Protocol

The Protocol function allows the user to select the appropriate measurement protocol for the test about to be performed. To select the measurement Protocol, press the **Protocol** button from the **Main Menu**.

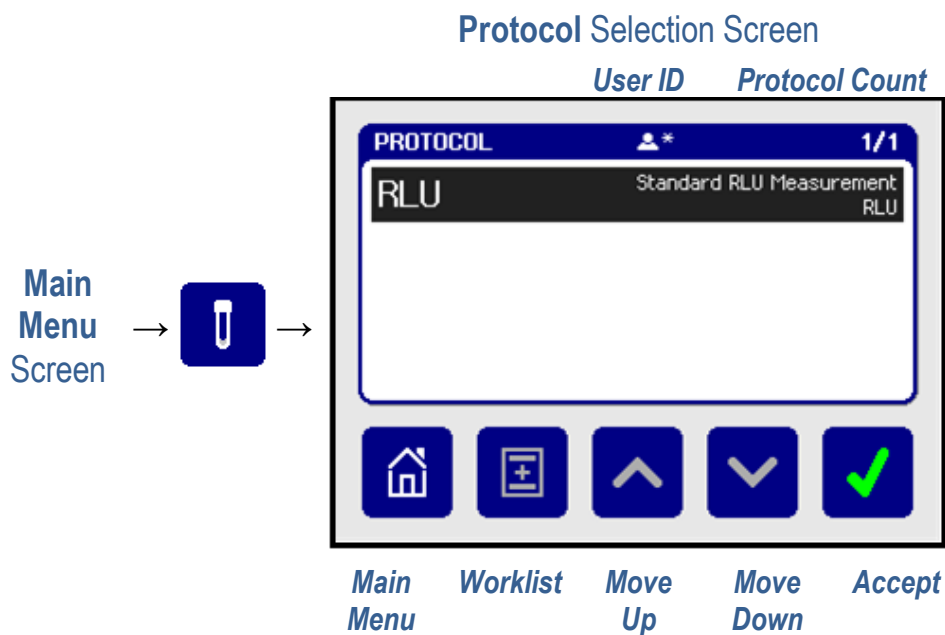

By default, the **Protocol** selection list consists of just the **Standard RLU Measurement** with no other protocols to choose from, therefore the **Up** and **Down** buttons at the bottom of the screen are greyed-out.

The **Worklist** button is also greyed-out at this point (see Section 7.7.2.3).

There is a small **User ID** icon at the top of the protocol screen to indicate the currently active User ID.



Additional Protocols and Worklists can only be added and edited via the Lu-mini Windows Application. See Section 7.7 for details.

Once the required Protocol has been selected, press the **Accept** button to start the testing procedure.

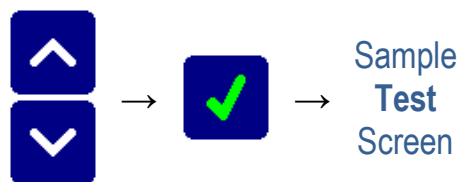

6.4.2 Editing the Sample ID

The top left corner of the Test screen shows the **Sample ID** which is a unique ID assigned to the reading result. The figure in the top right corner of the screen shows how full the results Database is.

In the middle of the screen the selected protocol is displayed along with the time and date; and visual prompts to instruct the user on how to perform a reading.

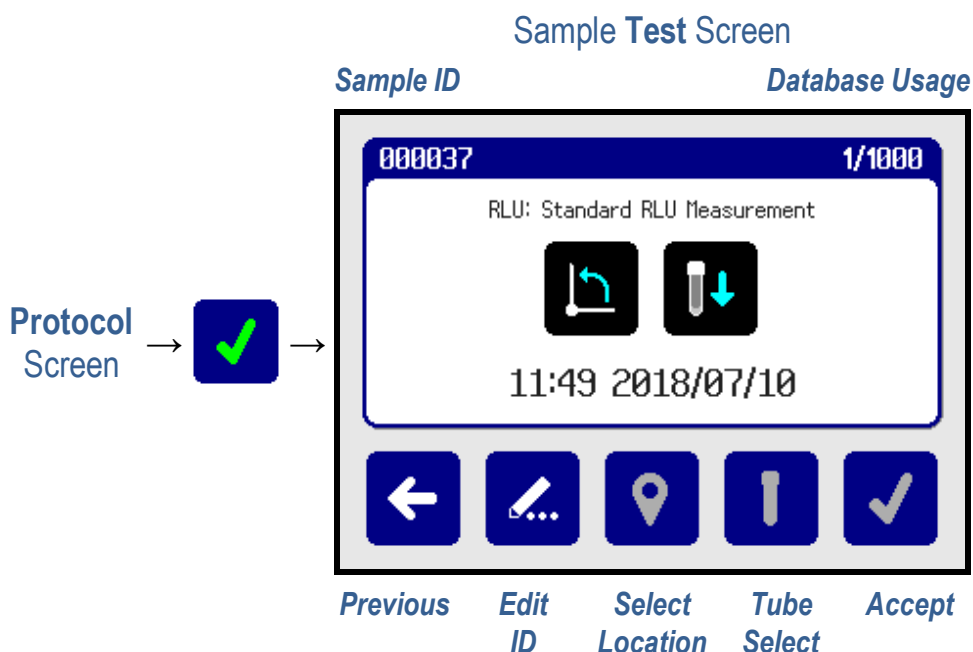

The default Sample ID allocation is a sequential numerical ID - however other Sample ID options can be selected from the unit **Set-up** options menu (see Section 6.7.4 for details).

If desired, the sample ID can be edited at this point by pressing the **Edit** button. If this is not required, skip forward to Section 6.4.4.

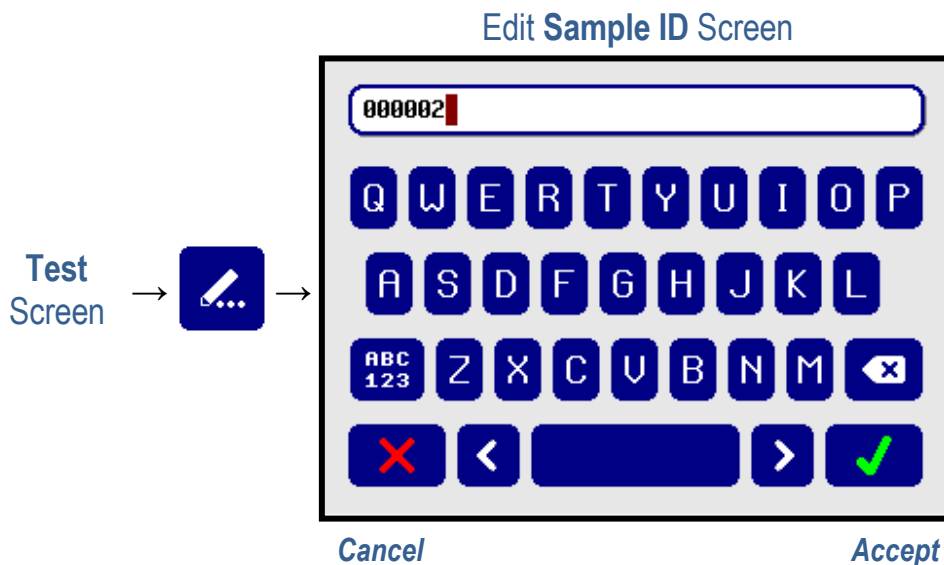

Using the keyboard, the Sample ID can be entered or edited. Once the desired ID has been entered, press the **Accept** button to continue or the **Cancel** button to undo and return to the **Test** screen.

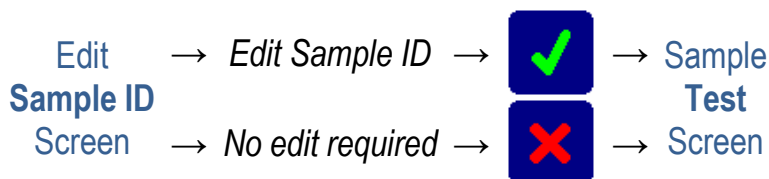

If the unit has been set-up to have no automatic Sample ID (see Section 6.7.4) the QWERTY keyboard will automatically appear as soon as the test begins.

At the bottom of the sample **Test** screen, the **Location** and **Tube Select** buttons are greyed-out as these features are only available when using the Lu-mini Windows Application. See Section 7 for details.

6.4.3 Sample Vessel Insertion and Removal

Once the **Sample ID** has been set (see Section 6.4.2), insert the test sample vessel into the reader sample chamber using the following procedure.

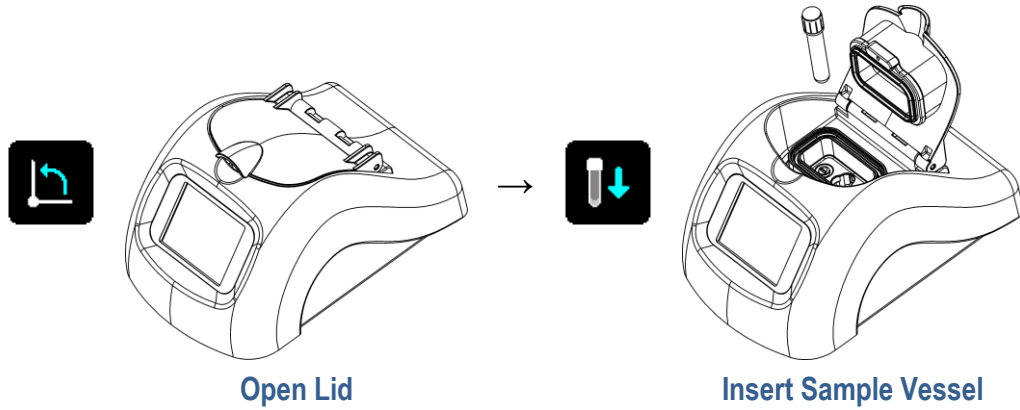

Ensure that the sample vessel is fully pushed down into sample chamber until the bottom of the vessel is touching the bottom of the chamber.

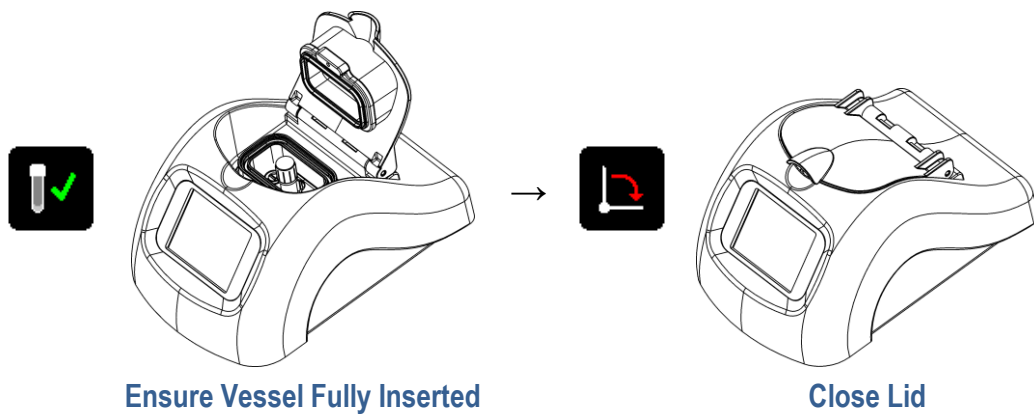

Once inserted, vessels that are less than 50mm tall are almost completely enveloped by the sample chamber and cannot be easily retrieved by hand.

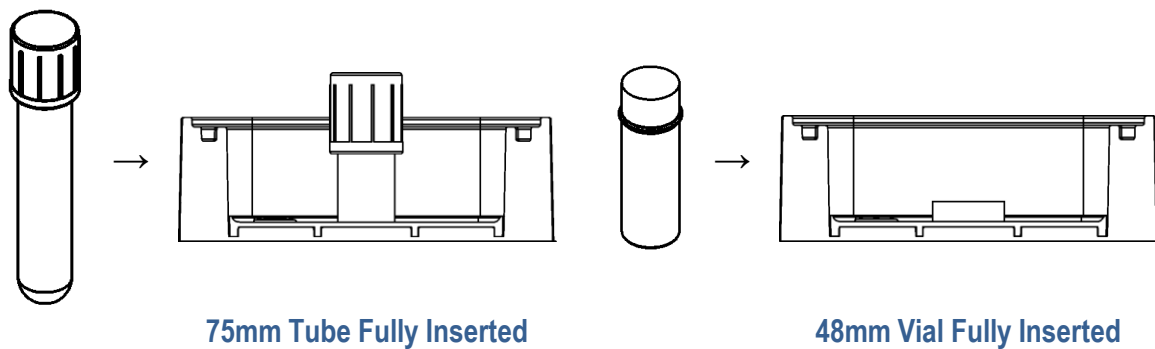

The Lu-mini features a push button to allow for easy removal of short sample vessels. The vessel **Eject** button is located next to the Reader Sample Chamber inside the unit (see Section 4).

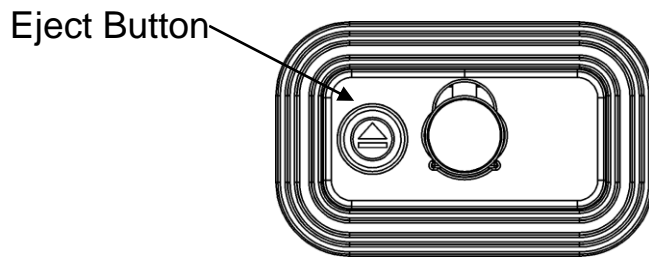

To remove a sample vessel from the reader sample chamber, use the following procedure:

- 1) Open the unit lid when instructed.



- 2) If the vessel is easily accessible then it can be simply removed by hand. If the vessel is difficult to access then the **Eject** button can be used.
- 3) Use a finger to push down on the eject button, as the button is depressed the vessel will be pushed up out of the sample chamber slightly.
- 4) Release the eject button.
- 5) There should now be enough of the vessel protruding from the chamber to allow easy removal by hand.

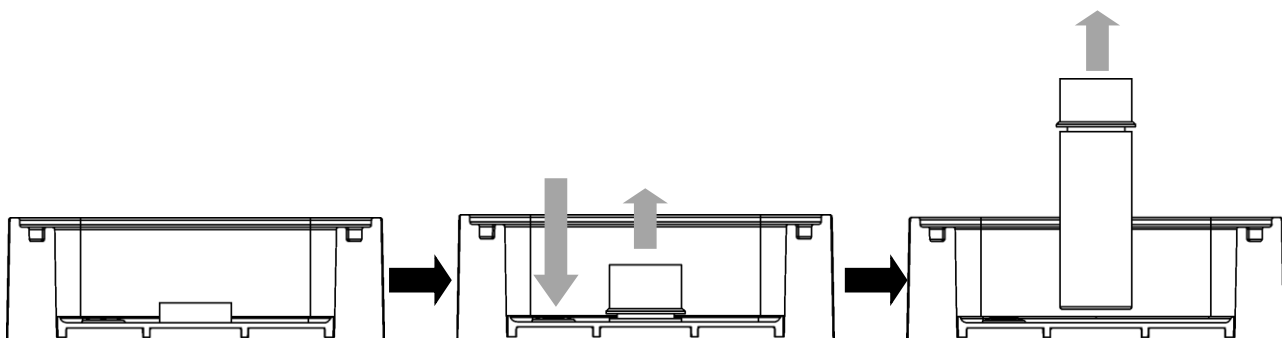

6.4.4 Performing a Reading

Once the sample vessel has been inserted into the unit and the lid closed (see Section 6.4.3 above), press the **Accept** button start the reading.

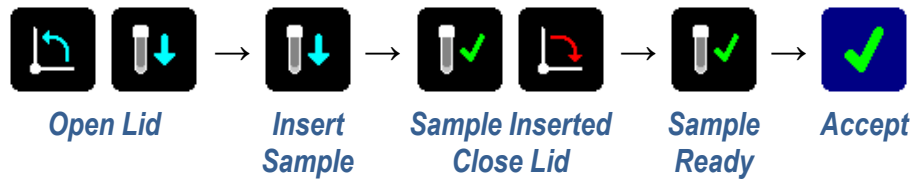

A measurement countdown begins.

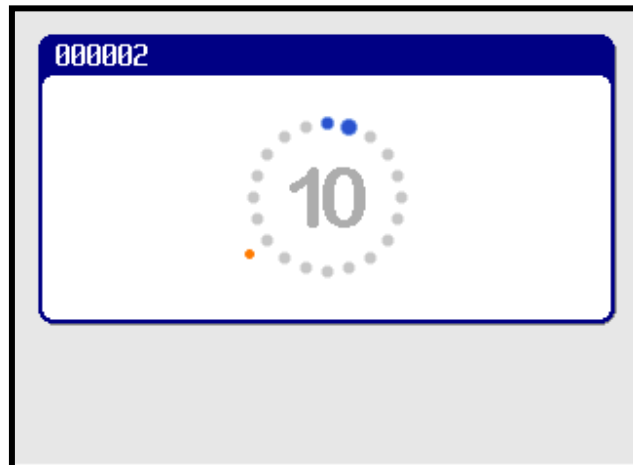

The reading result is displayed at the end of the countdown period on the **Test Results** screen.

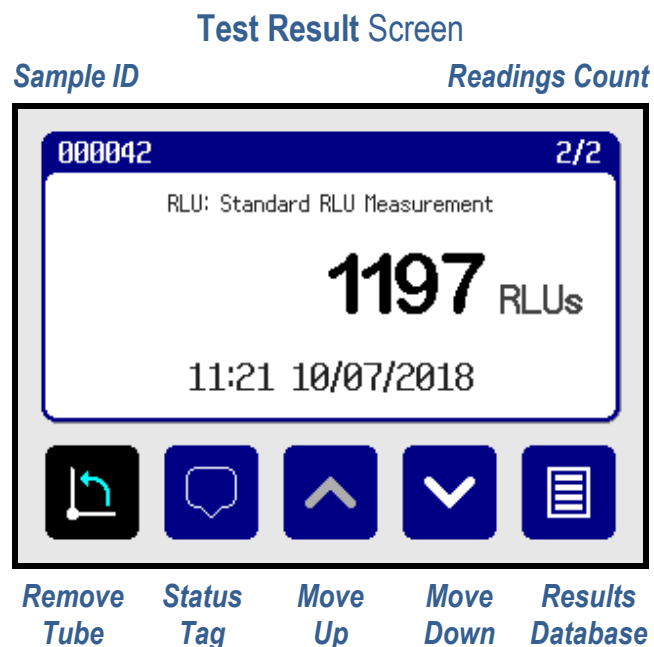

At this point the user can choose to either:

- 1) View the Test Results Database (Section 6.5)
- 2) Tag the result (Section 6.4.5)

- 3) Perform another sample test (continue)
- 4) Return to the Main Menu (continue)

To perform another sample test or return to the Main Menu, open the unit lid and remove the sample tube just tested. See Section 6.4.3 for sample vessel removal.

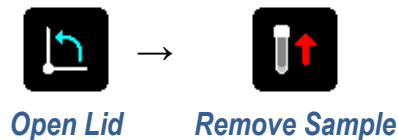





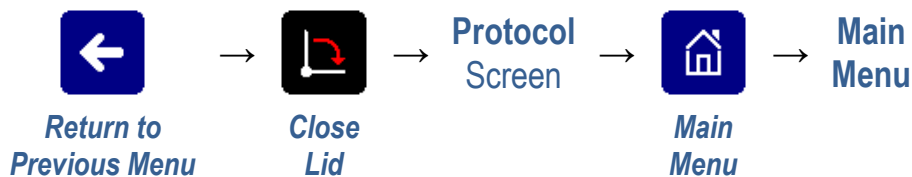

The sample **Test** screen will then appear. To perform another test, follow the visual prompts in the middle of the screen as detailed in Sections 6.4.2 thru 6.4.4 above.

Otherwise, to return to the **Main Menu** press the **Previous Menu** button and follow the visual prompts. This will then navigate the user back to the protocol screen where the **Main Menu** button can be pressed to return to the main menu.



6.4.5 Results Status Tagging and Adding a Comment Note

Each test result can be tagged with a **Status** icon to signify its overall result status – as listed in Table 8 below.

Table 8: Result Status Tag Symbols		
	None: Status unspecified	⇔
	Good: Good protocol test result	⇔
	Uncertain: Unclear protocol test result	⇔
	Bad: Bad protocol test result	⇔
	Flagged: Result flagged as <i>interesting</i>	⇔
	Invalid: Invalid/out-of-range test result	⇔

The **Status** tag can be added to the result immediately after the test has been completed (and before the tube is removed) or when reviewing test results via the results **Database** (see Section 6.5).

Press the **Status** tag button to access the status options.

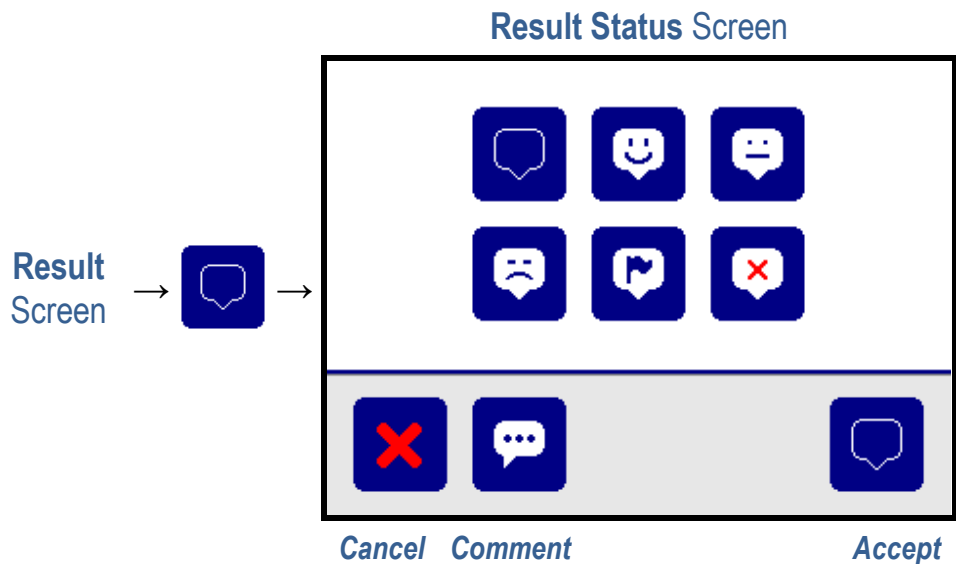

 For user-defined Protocols (see Section 7.7), the unit's user can be prevented from changing the pre-assigned status value, in which case the status option buttons are greyed-out.

The **Comment** button can be used to add a short note to the test result. This is particularly useful when the **Flagged** status option is selected. This text will appear in the **Notes** field of the Lu-mini App **Test Results Database** table.

To change the result status, press the required **Status** button in the middle of the screen. The display will jump back to the result screen with the new status value shown at the bottom of the screen.

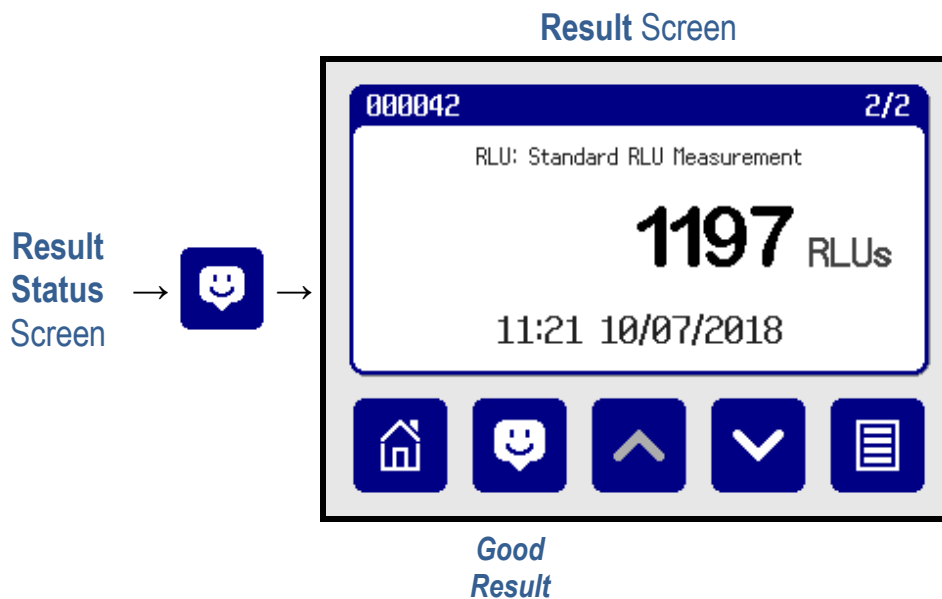

The **Status** tag and **Comment** can be changed at any time by pressing the **Status** button from the Results screen and selecting a different status option.

6.5 Viewing the Test Results Database

The test results **Database** is where all the test results are stored and can be accessed either from the main menu or test results screen. To view the database from the main menu, select the **Database** button.

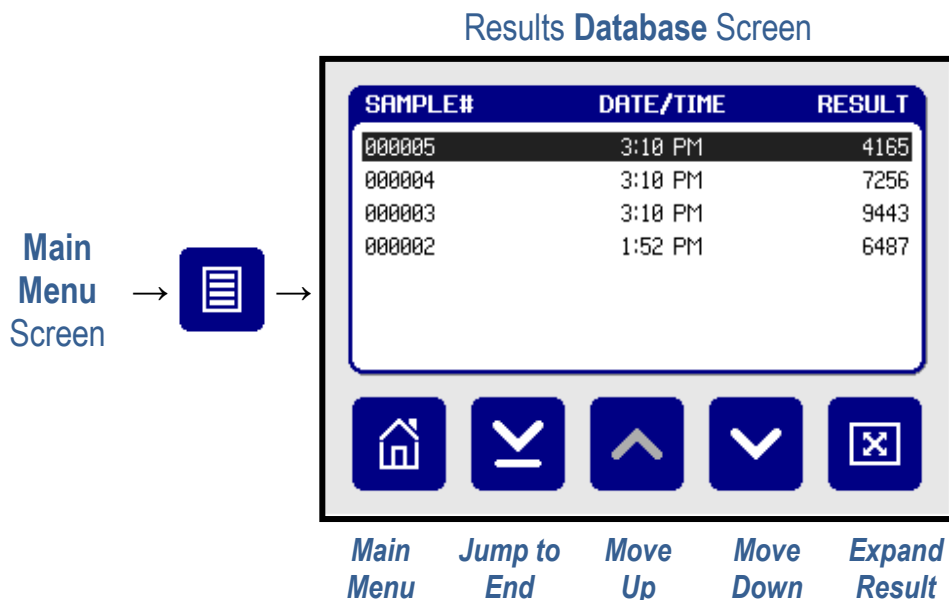

The Database screen displays a list of all the test results that have been completed. Results are listed in date/time order with the most recent test at the top of the list.

The **Up** and **Down** buttons can be used to scroll up and down the list one test at a time or alternatively use the jump to **Top** or **Bottom** buttons to quickly jump to the top or bottom of a long list of results.

When a result is highlighted the **Expand** button can be used to view the full-size results screen for that specific result.

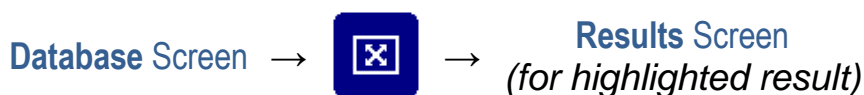

Press the **Database** button to return to the database screen.



Likewise, the test results **Database** can also be accessed directly after a reading has been taken by pressing the **Database** button.

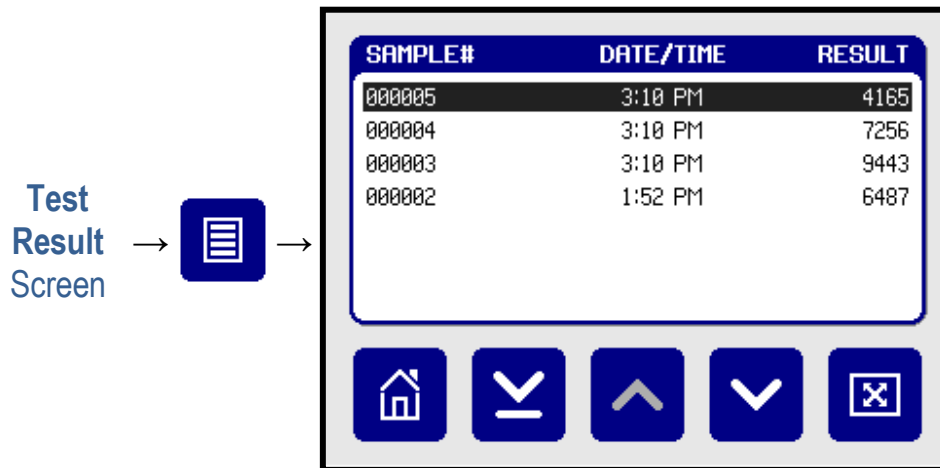

6.5.1 Deleting Test Results from the Lu-mini Database









Test results cannot be directly deleted from the Lu-mini's Results Database. However, they can be tagged as **Invalid** using the result status tag (see Section 6.4.5 for details).



Results can only be deleted from the unit via the Lu-mini Windows Application. See Section 7.4.1 for details.

6.6 Using the Timer Function

The **Timer Function** provides up to 8 timers that can be individually set from 5 seconds up to 95 minutes. The timers can be operated independently of each other or grouped together so that when one timer finishes the next one automatically starts.

Table 9: Timer Function Buttons and Status Symbols		
	Select Timer (1 of 8)	⇒ 6.6
	Start Timer	⇒ 6.6.1
	Stop Timer	⇒ 6.6.1
	Silence Timer Alarm	⇒ 6.6.1
	Unlinked Independent Timer	⇒ 6.6.2
	Linked Cascading Timer	⇒ 6.6.2
	Status: Timer Inactive (stopped)	⇒ 6.6.1
	Status: Timer Running (started)	⇒ 6.6.1
	Status: Timer Alarming (beeping)	⇒ 6.6.1

From the **Main Menu** press the **Timer Function** button to view the Timer Summary screen.

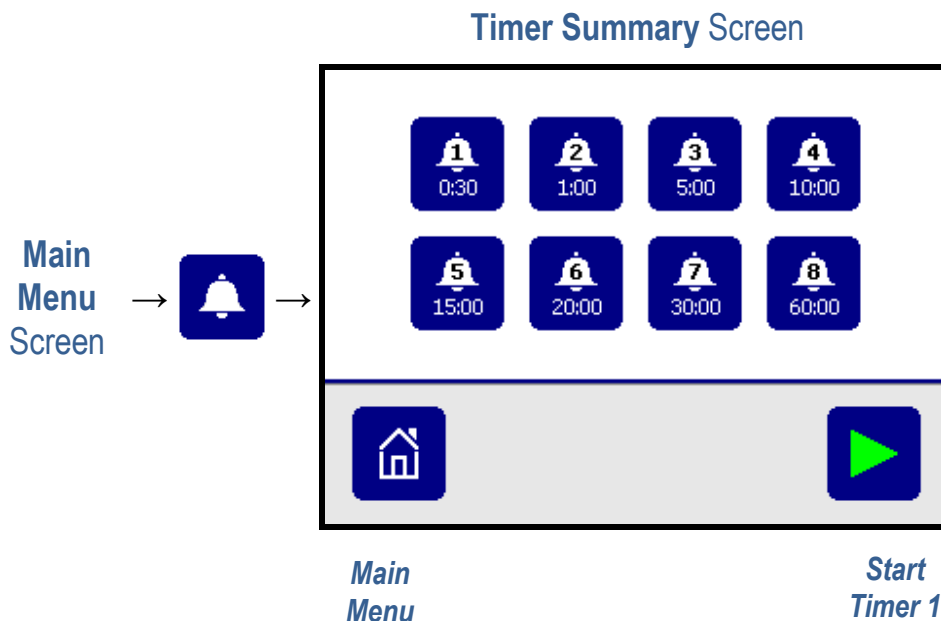

The Timer Summary screen displays all 8 timers, labelled 1 to 8, with each being assigned a default time between 0:30 seconds to 60:00 minutes.

6.6.1 Using an Independent Timer

To use a single independent timer, select a **Timer** from the Timer Summary screen (e.g. Timer 1 with a default time of 0:30 seconds) to pull up the Timer Details screen for that timer.

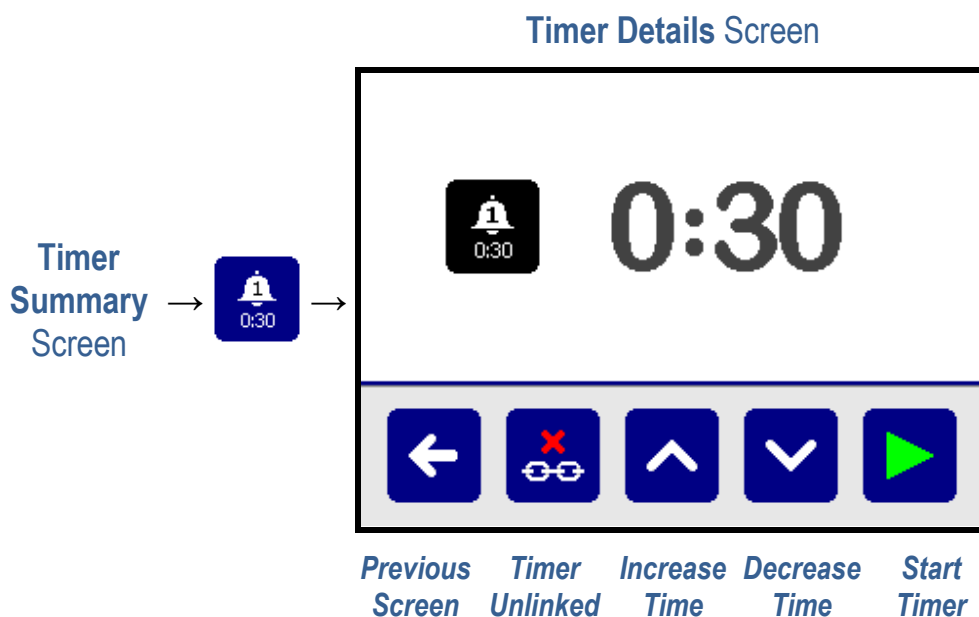

The timer duration can be set between 0:05 seconds and 95:00 minutes by using the **Increase** and **Decrease** buttons.

The **Timer** can then be immediately started by pressing the **Start** button. The button will change to a **Stop** button and the time will start counting down. The **Timer** can be cancelled at any time before it reaches **0:00** by pressing the **Stop** button.

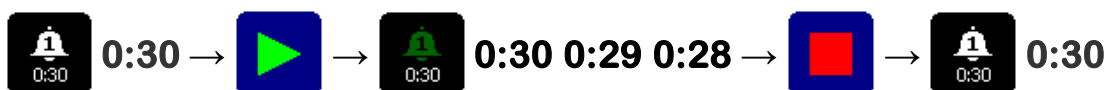

If the **Timer** is left to reach **0:00**, the timer **Alarm** starts sounding and the **Stop** button changes to a **Silence** alarm button. Press the **Silence** button to stop the **Alarm** and reset the **Timer**.

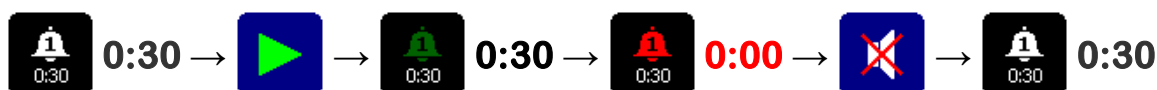

Press the **Previous** button to return to the Timer Summary screen.

Multiple timers can be started by pressing the **Timer** select button to go into the individual Timer Details screen, pressing the **Start** button to start the timer and then the **Previous** button to return to the Timer Summary screen; and then selecting the next timer to be started; and so on.

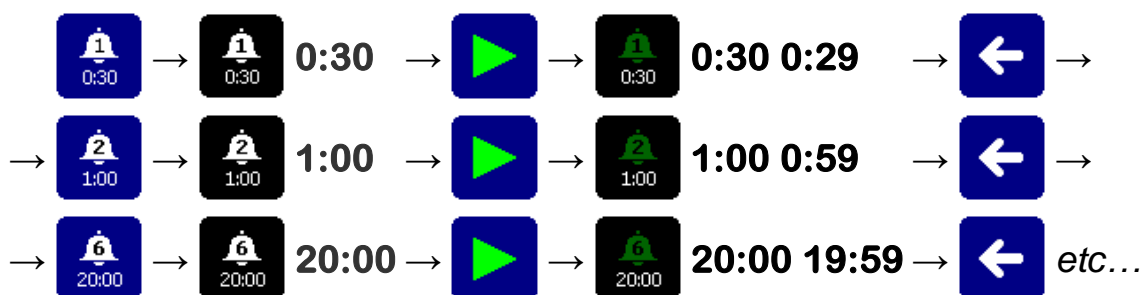

The status of all 8 timers can then be monitored, **Stopped** and **Silenced** from the main Timer Summary screen.

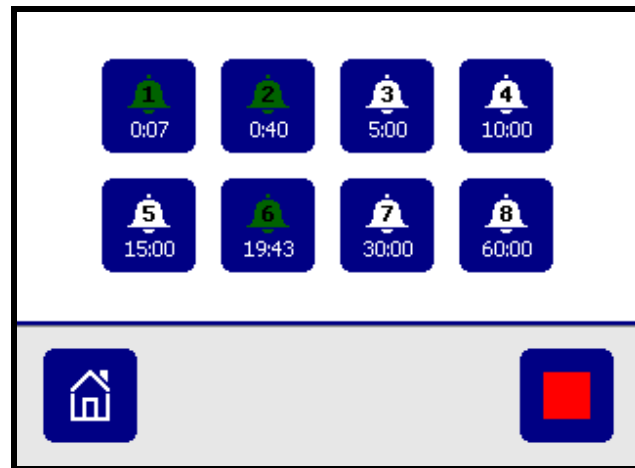

6.6.2 Using Linked Cascading Timers

If required, some or all of the timers can be linked together so that when one timer finishes the next one automatically starts. A timer is always linked to the next sequential timer i.e. Timer 1 to 2, Timer 2 to 3, and so on.

All the timers can be linked together into a single group or multiple groups.

6.6.2.1 Linking Timers into a Single Cascading Group

Instructions on how to link timers are as follows:

- 1) Select a **Timer** from the timer summary screen e.g. Timer 1.
- 2) Edit the time if required.
- 3) Press the **Unlinked** button located at the bottom of the screen.

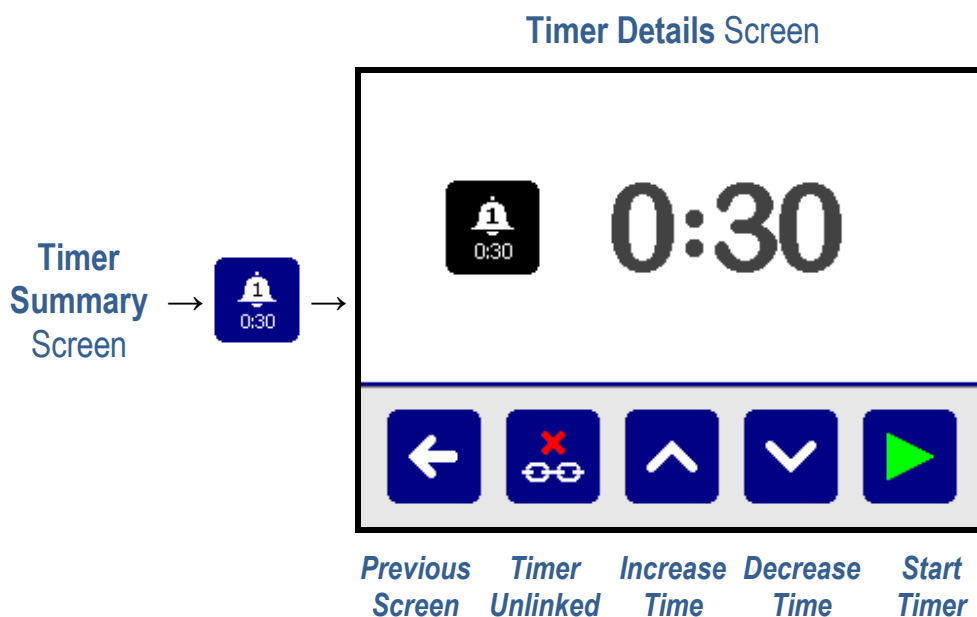

- 4) On the **Link Edit** screen press the **Link Timer** button, and then the **Accept** button to save the new setting.

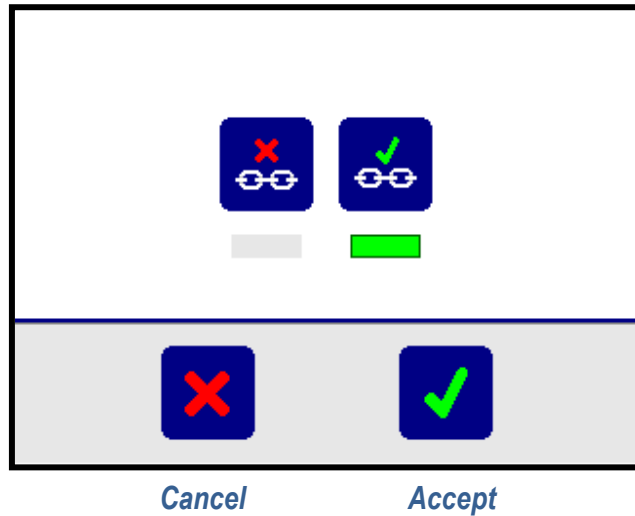

- 5) The Timer screen now shows the **Timer Linked** button and that Timer 1 is now linked to Timer 2.

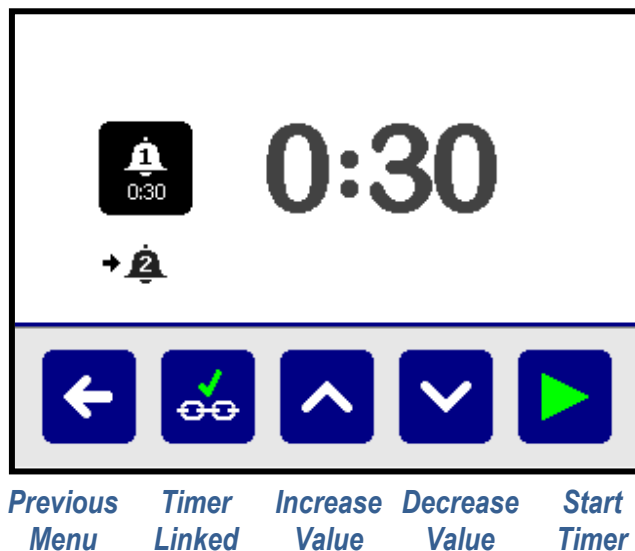

- 6) Return to **Previous menu**. There is now a small arrow between Timer 1 and Timer 2 to show they are linked.



- 7) Select Timer 2 and edit the time as required before returning to the **Previous menu**.
 8) Press the **Start** button to start the Timer 1.

- 9) Timer 1 will start counting down until it finishes, then Timer 2 will start automatically.

More timers can be added into a linked group by activating the linked function in each timer sequentially i.e. Timers 3, 4, 5, 6, 7 and 8.

6.6.2.2 Linking Timers into Multiple Cascading Groups

Multiple groups of linked Timers can also be set-up if required i.e. Timer 2 linked to 3 and then Timer 5 linked to 6. To create more than one linked group the timer at the start of a new group must not already be linked to the previous timer.

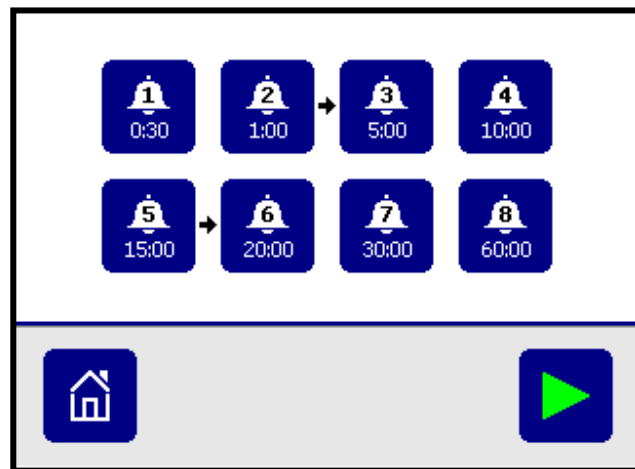

Multiple timer groups are started by pressing the **Start** button on the individual timer screen for the first timer in each group.

6.6.3 Using the Timers whilst Sample Testing

It is possible to use the unit as normal whilst the timers are running. Once a timer has been started press the **Main Menu** button to return to the main menu. From there the unit can continue to be used as desired.

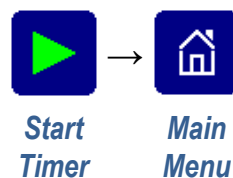

The active timer/s will not be visible on the unit display however, when a timer finishes the alarm will sound and this can be muted by pressing anywhere on the display no matter what screen is displayed.

6.7 Unit Set-up Options

The unit **Set-up** menu provides options for customising the unit’s behaviour and shows the current state of the settings.

Press the **Set-up** button from the Main Menu screen to view the Set-up Options menu.

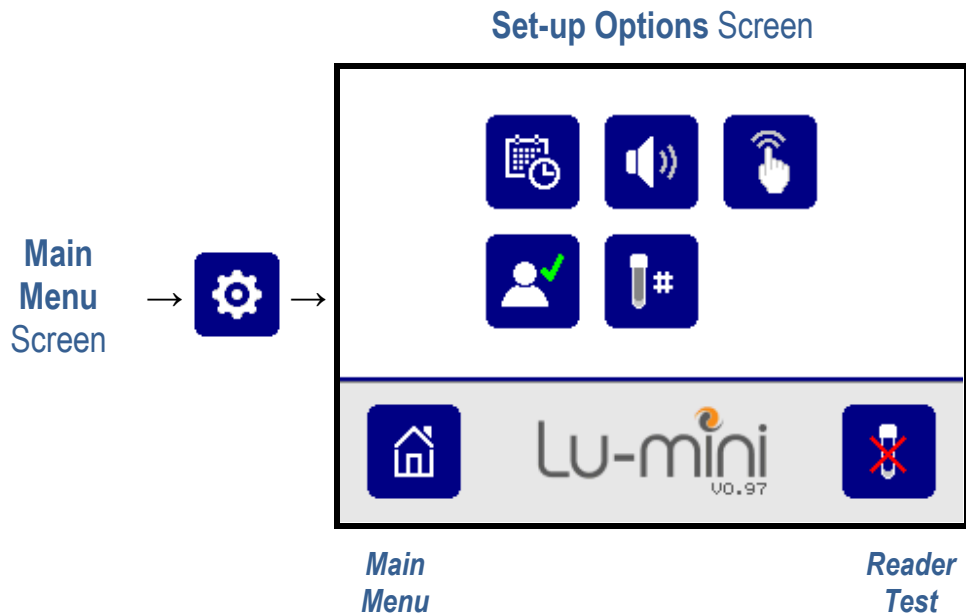

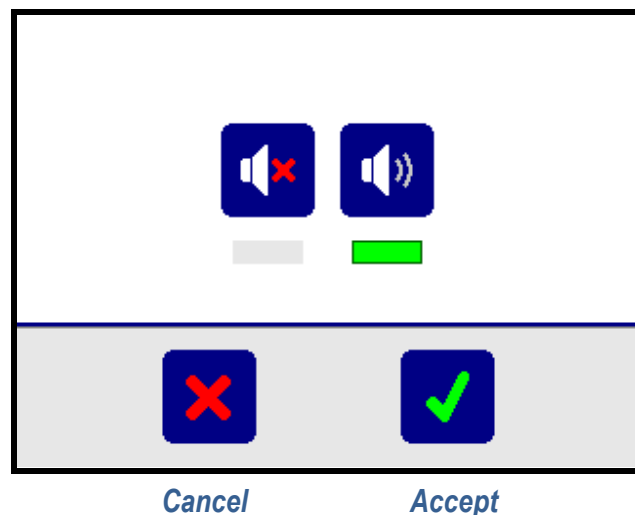

To change a setting, press the associated option button in the middle of the screen to select a new value (designated by the green bar) and press the **Accept** button to save the new setting.

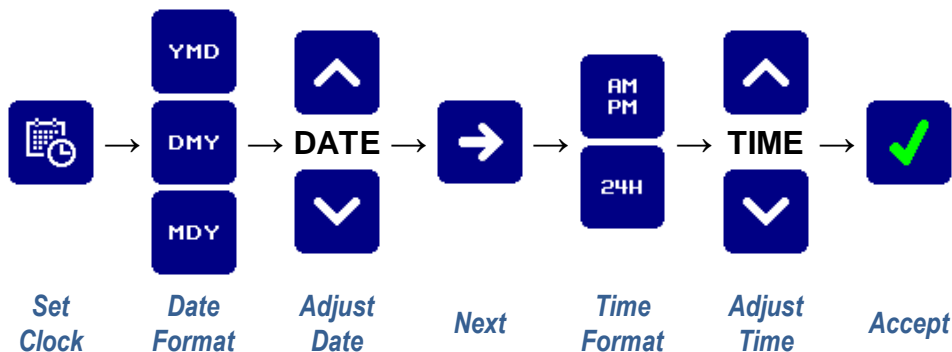

6.7.1 Setting the Clock and Date/Time Formats

The clock option allows you to change the unit date and time, as well as the date and time formats (as listed in Table 10).



 If using the Lu-mini Windows App, the date and time can be automatically set and synchronised with the computer's clock. See Section 7.6 for details.

6.7.2 Beeper and Button Click Volume

The unit beeper sounds at the end of each sample measurement and when a timer has finished. This can be **Muted** if required.



Likewise, the LCD touch screen button click can be independently set to **Silent** if desired.



6.7.3 Remembering the Last Active User ID

By default, the unit is set to remember the last active **User ID** each time the unit is powered up. This option can be changed so that the **User ID** reverts back to **Any User** on unit power-up.



6.7.4 Define Automatic Sample ID Text Format

The Sample ID text format can be edited as required using the sample ID editor function. From the Set-up menu select the **Sample ID Auto-text** button.

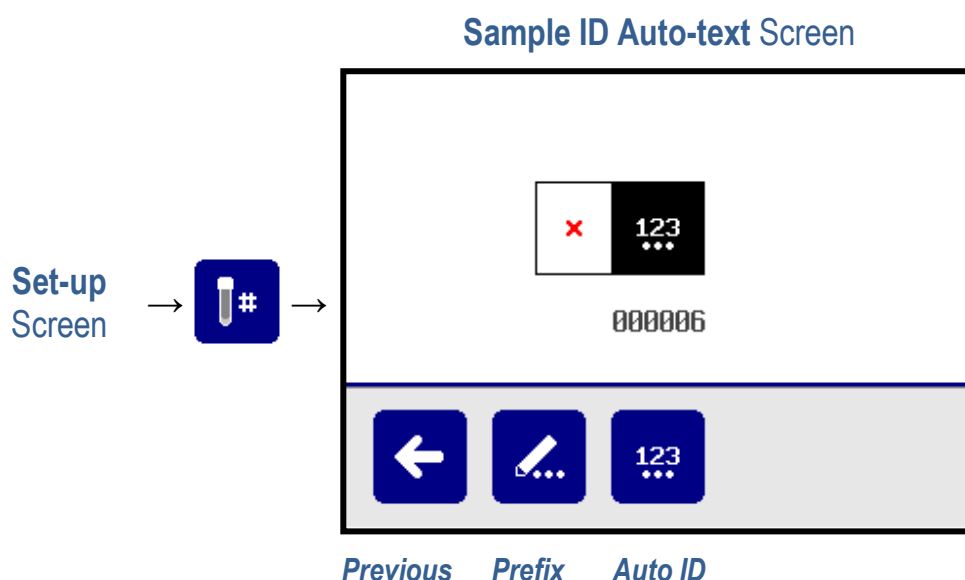

By default, the sample ID is set to sequential numeric with no prefix. All the options for ID editing available are detailed in Table 11.

Table 11: Automatic Sample ID Buttons

	Edit Prefix Text (0 to 6 characters)	<i>ABCDEF</i>
	No Automatic ID	
	Sequential Numeric ID (6 digits)	<i>123456</i>
	Daily Sequential ID (10 digits)	<i>YYMMDD-123</i>

The Sample ID can be a maximum of 16 characters long i.e. if set to a Daily Sequential ID with a 6-character prefix. Press the appropriate button/s to set the sample ID as required.

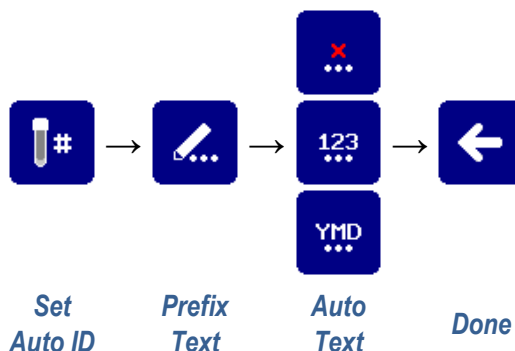

It is possible to have no automatic ID and no prefix set. In this instance when the **Accept** button is pressed on the Protocol screen just before a test (see Sections 6.4.1 and 6.4.2) the QWERTY keyboard will automatically be displayed. A sample ID must be given to the sample before a test can be performed.

6.7.5 Reader Test Mode

The reader test mode allows background reading to be performed either with or without a sample vessel present in the unit.

Press the **Reader Test** button on the set-up menu to display the reader test mode screen.

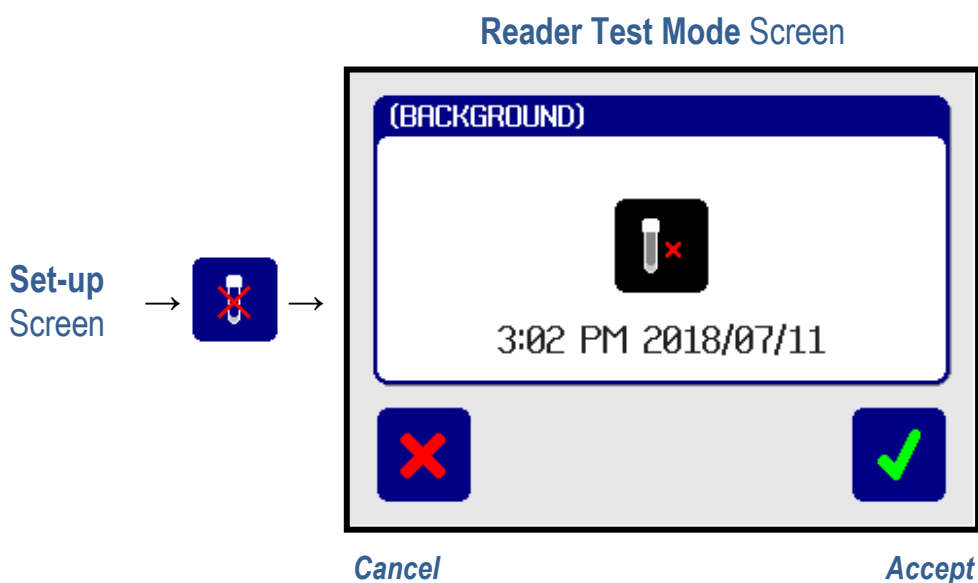

Press the **Accept** button to perform a reading using the Standard RLU Measurement protocol. When the test result is displayed, either press **Accept** to perform another reading or press **Previous** to return to the Set-up Menu.

Note: As these are only background test readings, they are not stored in the unit's results database.

6.8 Standby Mode and Unit Shutdown Procedure

After use, and before switching off the power to the unit, it is recommended to put it in standby mode.

Firstly remove any sample tube that may be present in the unit, and close the unit lid.

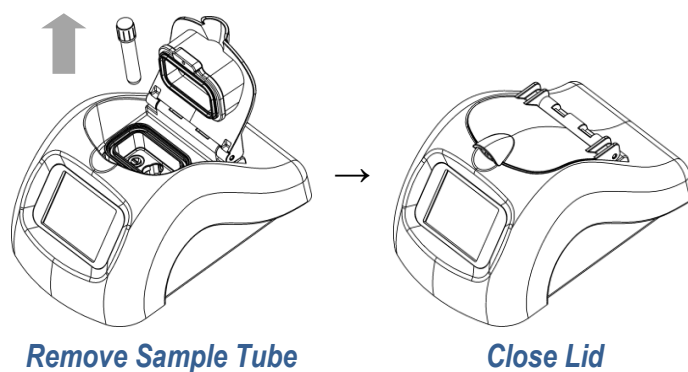

Then, on the Main Menu screen, press the **Standby** button to activate the standby mode.

Standby Mode Screen

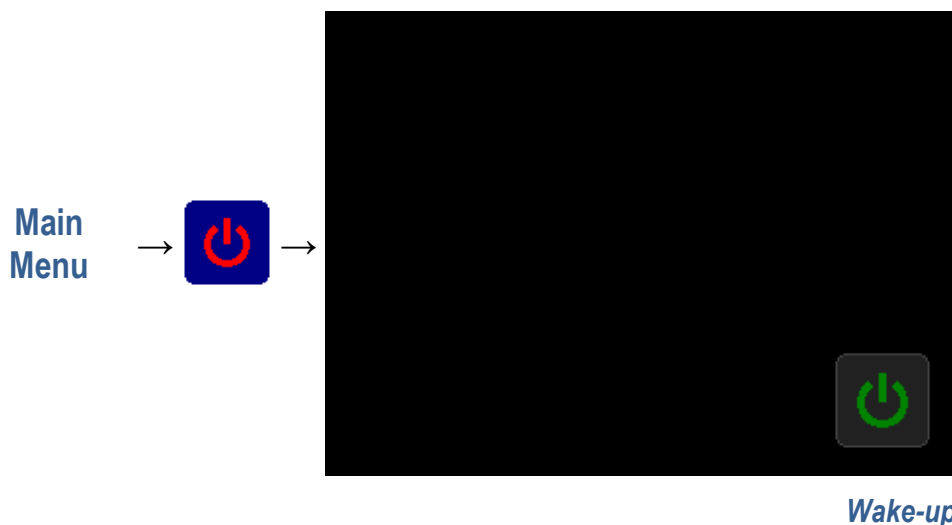

Once the unit is in standby mode then the power can be safely removed.



When the power to the unit is switched off or disconnected, the LCD may remain illuminated for several second before going blank.

To wake-up the unit from standby mode, press the **Wake-up** button on the standby screen.

7 Lu-mini Windows App and Advanced Unit Configuration

The Lu-mini Windows App activates the following advanced settings and features on the Lu-mini Unit:

- Uploading of Test Results to a command results Database
- Export of Test Results to an Excel compatible CSV file
- Creation of User IDs with optional passwords
- Creation of custom Protocols and Assays
- Management of multiple Lu-mini units to ensure common settings

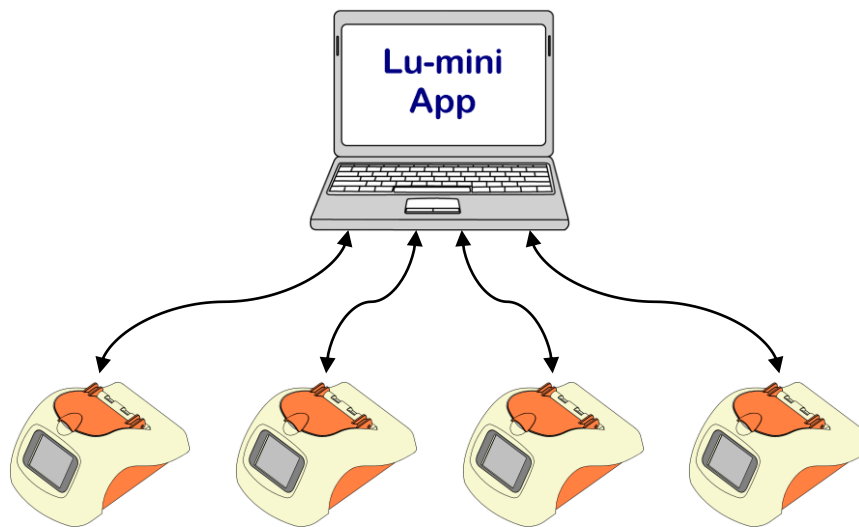

Multiple Lu-mini units can be connected to a single computer using several USB ports and a powered USB hub.

7.1 Installing the Lu-mini Windows App and USB Driver

DISCLAIMER

THIS SOFTWARE IS PROVIDED "AS IS" WITHOUT WARRANTY OF ANY KIND EITHER EXPRESSED OR IMPLIED INCLUDING BUT NOT LIMITED TO WARRANTIES OF MERCHANTABILITY OR FITNESS FOR A PARTICULAR PURPOSE.

INTEGRATED TECHNOLOGIES LTD SHALL NOT BE LIABLE FOR ANY LOSS OF PROFIT, LOSS OF USE, LOSS OF SOFTWARE, LOSS OF DATA, INTERRUPTION TO BUSINESS, NOR FOR ANY DIRECT, INDIRECT, INCIDENTAL, SPECIAL, EXEMPLARY OR CONSEQUENTIAL DAMAGES OF ANY KIND ARISING FROM THE USE OF THIS SOFTWARE OR RELATED THIRD-PARTY SOFTWARE WHETHER UNDER THIS AGREEMENT OR NOT.

BY INSTALLING OR USING THIS SOFTWARE YOU ARE AGREEING TO BE BOUND BY THE CONDITIONS OF THIS AGREEMENT.

To install the Lu-mini App, run the **Install.msi** file from the Installation Disk to initiate the install procedure. Then follow the on-screen prompts.



The Lu-mini App is designed to run on 32-bit and 64-bit versions of Windows 7, 8 and 10. To install the software you may require additional **Administrator** rights from your IT Administrator.

Next the USB Driver must be installed. This is done by running the appropriate install program from the **USB Driver from CP210x_Driver** sub-folder on the Installation Disk and following the onscreen prompts:

- For 64-bit Windows: Run **CP210xVCPInstaller_x64.exe**
- For 32-bit Windows: **CP210xVCPInstaller_x86.exe**

Alternatively, this can also be done by selecting the **Install USB Driver** option from the **Help** menu in the Lu-mini App (see Section 7.2.3 from details).

7.2 Lu-mini App Basic Functionality





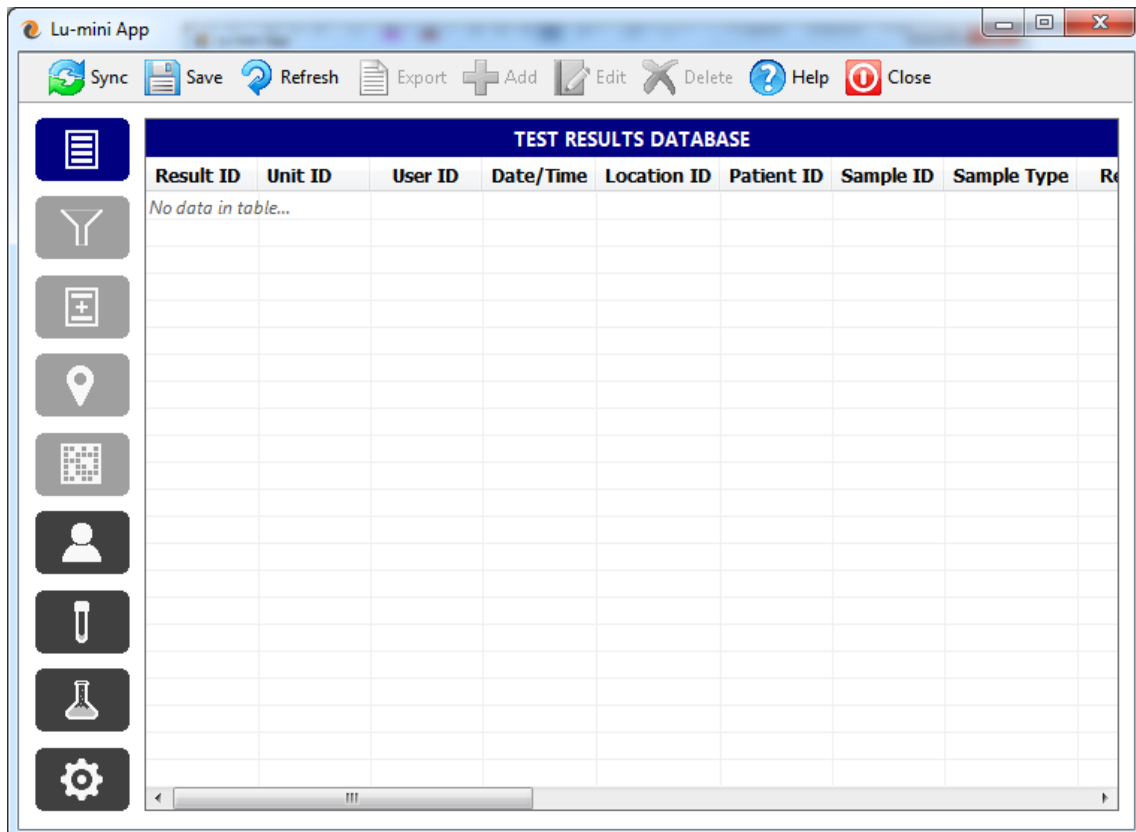



The Lu-mini App enables data to be transferred to and from the Lu-mini unit and a Windows computer, making it easy to add User IDs and customise the unit with specific sample measurement Protocols.

The application display format consists of a spreadsheet-style layout with **Page** selection buttons down the left-hand side of the screen and a **Toolbar** across the top.



7.2.1 Page Selection Buttons









The Lu-mini App features numerous spreadsheet-style **Tables**, which are selected by clicking the associated **Page** button down the left-hand side of the application Window.

Table 12: Lu-mini App Page Select Buttons		
	Test Results Database	⇒ 7.4
	<i>Future Feature: Test Results Database Filters</i>	
	<i>Future Feature: Scheduled Test Sample Work List</i>	
	<i>Future Feature: Sample Locations</i>	
	<i>Future Feature: Test Plans</i>	
	User IDs	⇒ 7.5
	Sample Measurement Protocols	⇒ 7.7
	Reagent Assays	⇒ 7.8
	Unit Settings	⇒ 7.6

Please refer to the subsequent Sections for more details.

7.2.2 Toolbar Options

The toolbar provides the basic data functions as follows:

Table 13: Lu-mini App Toolbar Options			
	Sync	Sync Lu-mini Unit to the Lu-mini App	⇒ 7.3
	Save	Save database changes to disk	⇒ 7.2.4
	Refresh	Refresh page	⇒ 7.2.4
	Export	Export data to Excel compatible CSV file	⇒ 7.4.2
	Add	Create new user, protocol, etc	⇒ 7.2.4
	Edit	Edit existing data within App	⇒ 7.2.4
	Delete	Delete existing data within App	⇒ 7.2.4
	Help	Help menu	⇒ 7.2.3
	Close	Close Lu-mini App	

Please refer to the specific Sections for more details.

7.2.3 Help Menu Options

The **Help Menu** is accessed by clicking on the **Help** button in the toolbar, and provides the following options:

Table 14: Lu-mini App Help Menu Options	
Instructions for Use	Open Lu-mini User's Manual
Install USB Driver	Install appropriate USB Driver
Check online for App Updates	<i>Future Feature</i>
Capture Unit Screenshot	Capture Lu-mini screen image
Reset Unit Software and Settings	<i>Future Feature</i>
About Lu-mini App	Lu-mini App software details

The **Install USB Driver** option can be used to install the Windows USB Driver for the Lu-mini Unit. Using this method, the application automatically detects the Windows version (32-bit or 64-bit) and loads the appropriate driver.

The **Capture Unit Screenshot** option can be useful for taking snapshots of the current display on the Lu-mini Unit, so that they can be pasted into your own standard operating procedure documents.

7.2.4 Data Table Field Editing and Context Menu

Each **Page** displays a specific spreadsheet **Table**, consisting of a matrix of data **Cells** organised in **Lines** (running down the sheet in rows) of related data **Fields** (arranged across the sheet in columns).

← Fields →

USER IDS				
Active	User ID	User Name	Password	Notes
Yes	*	Any User		
Yes	JS	Julie Smith	Cell	
No	RJ	Robert Jones		

↑ Lines ↓

Lines or **Cells** which are **greyed-out** cannot be changed. All other cells in the table can be edited in any of the following three ways:

- (a) Double-clicking on the **Cell** text

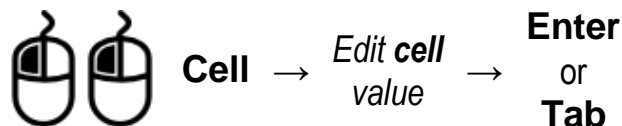

- (b) Right-clicking on the **Cell** and selecting the **Edit** option from the Context Menu



- (c) Selecting a table **Line** and then clicking the **Edit** button in the Toolbar



After changing the Cell text, press the **Enter** key to accept the new value; or press the **Escape** key to cancel editing; or press the **Tab** key to accept the new value and automatically move on to edit the next field cell in the line.



WARNING: There is currently no **Undo** button; hence any changes made to the table data cannot be easily reversed. The only way to restore the table values is to **Exit** the application or to use the **Refresh** button (see below for details).

When a data cell value has been changed, the line text colour changes to **blue** to signify that it has been modified but has not yet been saved to disk.

To save any changed to disk, simply click the **Save** button in the Toolbar. The modified lines will then turn black again.



If changes have been made to the data, but you have changed you mind, there is no **Undo** option. However, the entire data table can be reloaded from disk to the state it was when last saved by clicking the **Refresh** button.



New data **Lines** can be added to the end of the table in two ways:

- (a) Clicking the **Add** button in the Toolbar

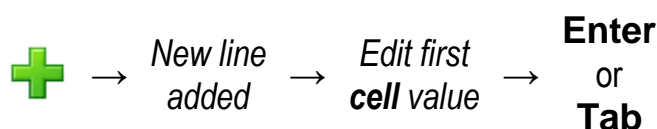

- (b) Right-clicking on a **Line** and then selecting the **Duplicate Line** option from the Context Menu

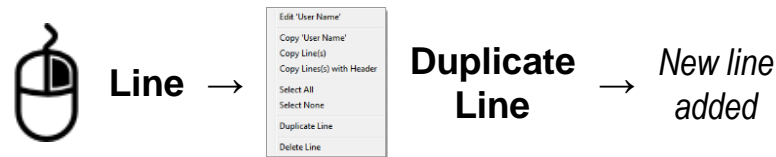

One or more data **Lines** can also be deleted in two ways:

- (a) Selecting the **Lines** to be deleted and then clicking the **Delete** button in the Toolbar



- (b) Selecting the **Lines** to be deleted and then Right-clicking on a **Lines** and then selecting the **Delete Line** option from the Context Menu



The full list of right-click Context Menu options are as per Table 15 below.

Table 15: Data Cell Context Menu Options		
Edit 'field'	Edit cell value	⇒ 7.2.4
Copy 'field'	Copy cell value to paste clipboard	⇒ 7.4.2
Copy Line(s)	Copy selected line(s) to clipboard	⇒ 7.4.2
Copy Line(s) with Header	Copy Header and Selected line(s)	⇒ 7.4.2
Select All	Select all lines	
Select None	Select no lines	
Duplicate Line	Duplicate entire line contents	⇒ 7.2.4
Delete Line	Delete selected line(s)	⇒ 7.2.4

Please refer to the associated Sections for more details.

7.3 Data Synchronisation

The toolbar **Sync** button is used to transfer data between the Lu-mini App and all attached Lu-mini Units, by performing the following tasks:

- Discover and add New Unit details ⇒ 7.6.1
- Upload test results from Unit ⇒ 7.4
- Delete test results from Unit’s database ⇒ 7.4
- Check for Unit Software updates
- Update Unit’s time and date settings [Optional] ⇒ 7.6
- Update Unit’s User IDs list ⇒ 7.5
- Update Unit’s Protocols list ⇒ 7.7

Click the **Sync** button on toolbar to initiate the data transfer. The Lu-mini Unit will display the Download screen until the process is complete.

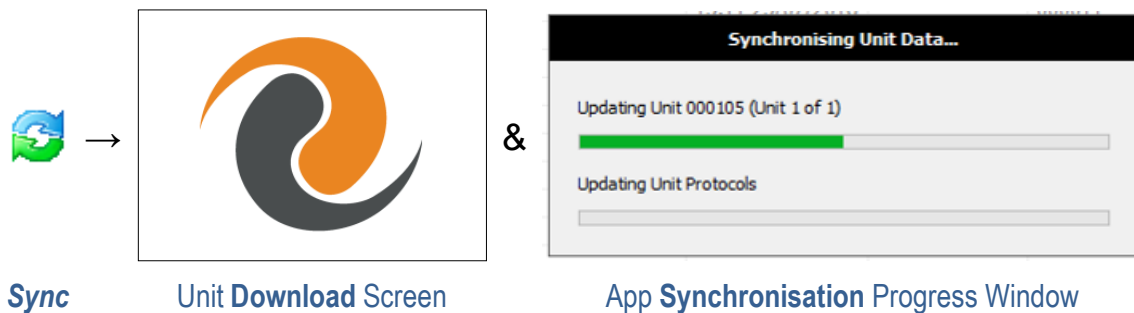

When synchronisation is completed, the Lu-mini Unit will restart. Click the **OK** button to close the progress window.

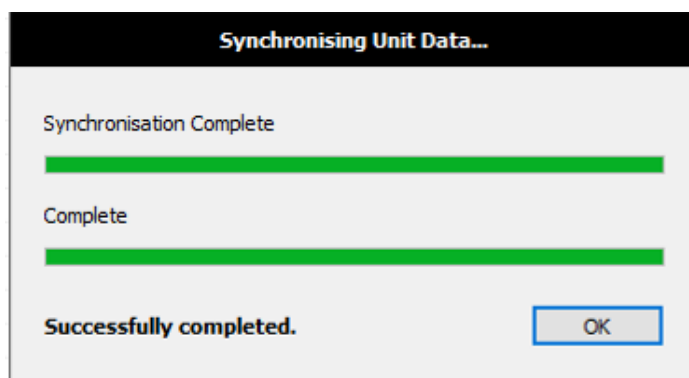

Once restarted, the attached Units will have any new User and Protocol data loaded on to them from the Lu-mini App, and the App will contain all the test results data from the Units.



NOTE: Uploading the test results removes them from the Lu-mini Unit and permanently stores them in the Lu-mini App **Test Results Database** table (see Section 7.4).

7.4 Test Results Database Page

The Test Results Database page stores all the test results that have ever been uploaded from the Lu-mini Units.

The available Test Results Database table data fields are listed in Table 16 below.

Table 16: Test Results Database Data Fields	
Results ID	Test result unique ID within the database
Unit ID	Unit serial number and name ⇒ 7.6.1
User ID	User ID ⇒ 7.5
Date/Time	Date and Time when sample test performed
Location	Sample location name
Patient ID	Optional: Patient ID from Worklist
Sample ID	Test Sample ID
Sample Type	Sample Type (S, C, 1, 2, 3, 4, 5 or 6) ⇒ 7.7.2
Protocol	Protocol name ⇒ 7.7.1
Measurement Type	Measurement type ⇒ 7.7.3
Tube Reading	Sample tube reading ⇒ 7.7.4
Reading Units	Reading Units-of-measurement ⇒ 7.7.4
Test Result	Test Result ⇒ 7.7.4
Results Units	Result Units-of-measurement ⇒ 7.7.4
Status	Overall test result Status tag ⇒ 6.4.5
Band	Banded result Name ⇒ 7.7.4
Lower Limit	Banded result lower limit ⇒ 7.7.4
Upper Limit	Banded result upper limit ⇒ 7.7.4
Notes	Optional: Additional notes ⇒ 7.2.4

None of these data field values can be modified except for the **Notes** field.

7.4.1 🌀 Uploading Results Data

Each time the Lu-mini App synchronises with Lu-mini Unit any new test results are uploaded and stored in the Test Results Database table.



Once the results have been uploaded and saved in the Lu-mini App they are automatically deleted from the Lu-mini Unit.

7.4.2 🌀 Exporting Test Results Data

Test results data can be exported to an Excel compatible CSV file by clicking the **Export** button on the toolbar. This can either be the all the data in the table, or just the selected lines.

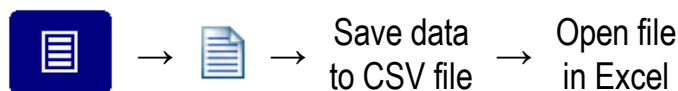

Alternatively, the data can be Copied and Pasted into an existing Excel sheet. This is achieved by selecting the **Lines** to be copied and then right-clicking on a **Lines** and selecting the **Copy Lines** option from the Context Menu.

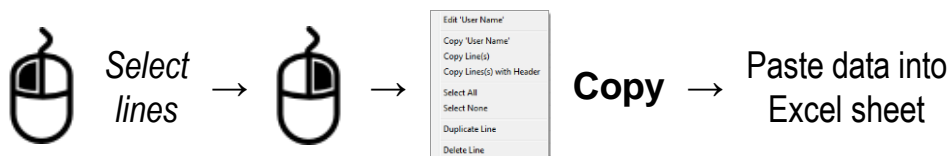

7.4.3 🌀 Deleting Results Data

Results are automatically deleted from the unit when they are uploaded to the application during the synchronisation process. All results data from the unit is stored on the application until it is deleted by the user.

To delete results data from the application's Test Results Database, refer the Section 7.2.4 for details.

7.5 User IDs Page

By default, the Lu-mini unit has only a single generic **Any User** user profile. This page of the application allows for custom User IDs to be created for the unit as required.

New users are created by adding a new line to the User IDs table (see Section 7.2.4).

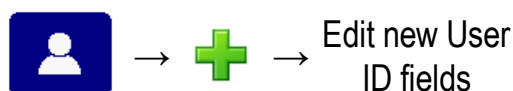

The available User IDs table data field options are listed in Table 17 below.

Table 17: User IDs Data Fields		
Active	Selects whether the User ID is downloaded to the unit	⇒ <i>Below</i>
User ID	Unique User ID	⇒ 6.3
User Name	Name associated with the User ID	⇒ 6.3
Password	Optional password	⇒ 6.3
Notes	Optional: Additional notes	⇒ 7.2.4

New User IDs will appear on the Lu-mini unit when the **Sync** button is next clicked.



New User IDs are created with the **Active** field set to **Yes**, meaning the User ID will be loaded onto the Lu-mini unit when it is next synchronised with the application.

There is no limit to the number of User IDs that can be created in the Lu-mini App, however only 50 active Users IDs can be stored in the Lu-mini Unit. Hence, to limit the size of this list, the **Active** field must be changed from **Yes** to **No** for some Users IDs.

7.6 Global Unit Settings Page

The Unit Settings table stores a list of all the Lu-mini units which have been synchronised with the Lu-mini App.

The available Unit Settings table data fields are listed in Table 18 below.

Table 18: Unit Settings Data Fields	
Unit Number	Fixed: Unique Lu-mini Unit serial number
Unit Name	Optional: Name that appears at the top of unit's Main Menu screen ⇒ 7.6.1
Last Synced	Fixed: The date and time with unit was last synchronised
Notes	Optional: Additional notes ⇒ 7.2.4

Time and Date Synchronisation options are listed in Table 19 below.

Table 19: Time and Date Synchronisation Options	
Time Format	AM/PM or 24H: Used on unit display and in the Test Results Database table ⇒ 7.4
Date Format	YYYY/MM/DD, DD/MM/YYYY or MM/DD/YYYY: Used on unit display and Test Results Database table ⇒ 7.4
<input type="checkbox"/> Automatically set unit time and date	Selects whether unit's time/date settings are automatically updated when by Sync update ⇒

7.6.1 Adding a New Unit

New Lu-mini units are automatically added to the **Unit Settings** table whenever a **Sync** is performed.

The **Unit Name** field can then be set with a short description that appears on the unit's Main Menu screen next time the unit is synchronised.

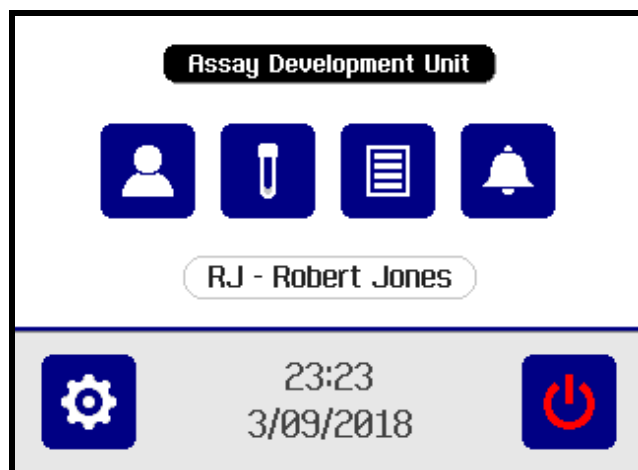

7.7 Sample Measurement Protocols Page

By default, the Lu-mini Unit has only the **Standard RLU Measurement** protocol. This page allows custom protocols to be created and developed as required.

To create a new Protocol, click the toolbar **Add** button and then enter all the appropriate data field values.

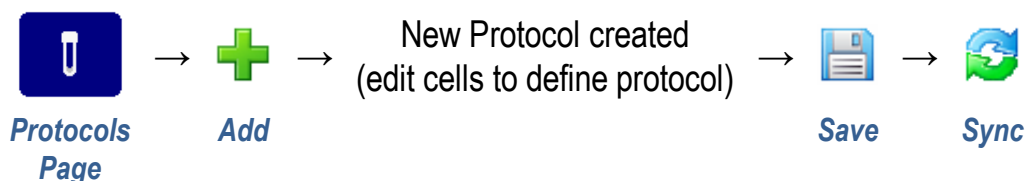

Alternative a copy of an existing Protocol can be copied and modified by right-clicking on the existing protocol **Line** and then selecting the **Duplicate Line** option from the Context Menu and editing the required data field values.

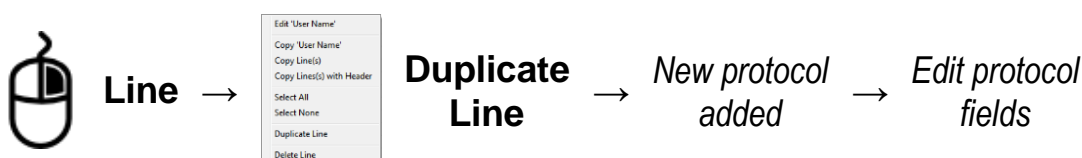

The available Sample Measurement Protocols table data fields are listed in Table 20 below.

Table 20: Protocols Table Data Fields		
Active	Selects whether protocol is downloaded to unit	⇒ <i>Below</i>
Protocol Name	Unique name for this protocol	⇒ 7.7.1
Description	Description of the protocol	⇒ 7.7.1
Assay	Assay name from Reagent Assay Table	⇒ 7.7.1
Scaling Factor	Assay reading scaling factor	⇒ 7.7.1
Sample Method	Sample method (S, C, C+1S to C+6S)	⇒ 7.7.2
Measurement Type	Sample measurement type	⇒ 7.7.3
Show Graph	Show data progress graph for long measurement times	⇒ 7.7.3
Pre-zero	Include automatic pre-zero before measurement	⇒ 7.7.3
T1	Result analysis time t1 in seconds	⇒ 7.7.3
T2	Result analysis time t2 in seconds	⇒ 7.7.3
Window	Result analysis window size in seconds	⇒ 7.7.3
Threshold	Percentage change threshold limit	⇒ 7.7.3
Result DPs	Result display number of decimal-places	⇒ 7.7.4
Result Units	Result Units-of-measurement	⇒ 7.7.4
Lock Status	Prevent user from changing the result status	⇒ 7.7.2
Result Banding	Result colour banding data	⇒ 7.7.2
Limit Result	Limit result value to maximum/minimum bands	⇒ 7.7.2
Comparison Bands	Comparative result acceptance range data	⇒ 7.7.2
Show Relative	Show comparative result as relative percent	⇒ 7.7.2
Notes	Optional: Additional notes	⇒ 7.2.4

The **Active** field can be used to specific which Protocols will be downloaded to the Lu-mini Units. This is handy when developing new or experimental Protocols to select only the active definitions.

Please refer to the relevant Sections for specific details on field usage.

7.7.1 Protocol Name and Reagent Assay

The first group of Protocol definition fields define the protocol name and associated Assay (see Section 7.8).

Protocol Name	Unique name for this protocol
Description	Description of the protocol
Assay	Assay name from Reagent Assay Table
Scaling Factor	Scale assay reading to allow for different units of measurement (0.000001 to 1000000.0 but normally 1.0)

The **Protocol Name** and **Description** appear on the Lu-mini Unit in the Protocol selection screen (along with the **Result Units** of measurement).

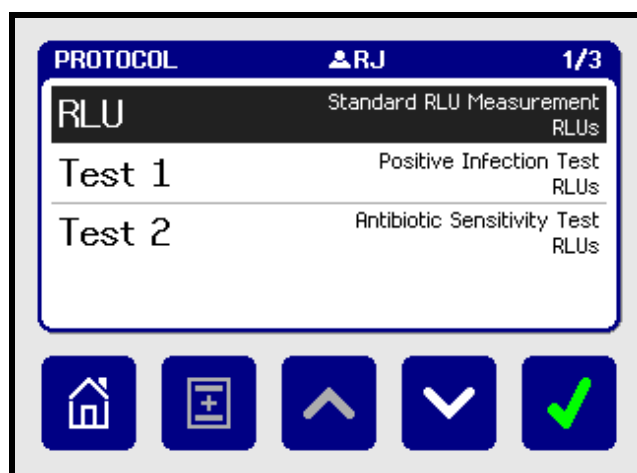

The **Assay** is the name of the **Reagent Assay** (see Section 7.8) being used for this protocol. Usually multiple protocols will use the same Assay.

The assay **Scaling Factor** can be used to convert the **Assay** output reading into different units of measurement (for instance) or to correct for calibration rescaling. See Section 7.7.4 for additional details.

7.7.2 Sample Method Types

The **Sample Method** field (listed in Table 20) defines how many related tests will be performed on a particular sample.

Table 21: Sample Method Options	
Single Sample	One standard test per sample volume
Control Only	One control test per sample (such as QC check)
Control + 1 Sample	One baseline control test plus one comparative standard test per sample
Control + 2 Samples	One baseline control test plus up to two comparative standard tests per sample
<i>etc</i>	<i>etc</i>
Control + 6 Samples	One baseline control test plus up to six comparative standard tests per sample

This setting determines how the Lu-mini Unit processes the sample tube readings and displays the result to the user.

7.7.2.1 🌀 Single Tube Measurements

For the **Single Sample** and **Control Only** options, the Unit measures a single test tube and presents the result in the specified numerical format with optional Banding (see Section 7.7.4).

7.7.2.2 🌀 Multiple Tube Measurements

For multiple sample tests (**Control + 1 Sample** thru **Control + 6 Samples**), however, the additional **Sample** results are compared against the baseline **Control** test result and displayed as a bar chart (see Section 7.7.4 for details).

The first sample test is always on the **Control** sample, and is represented as normal numeric value (see Section 6.4.4 for details).

When the **Control** tube is removed, the **Tube Selection** screen is displayed.

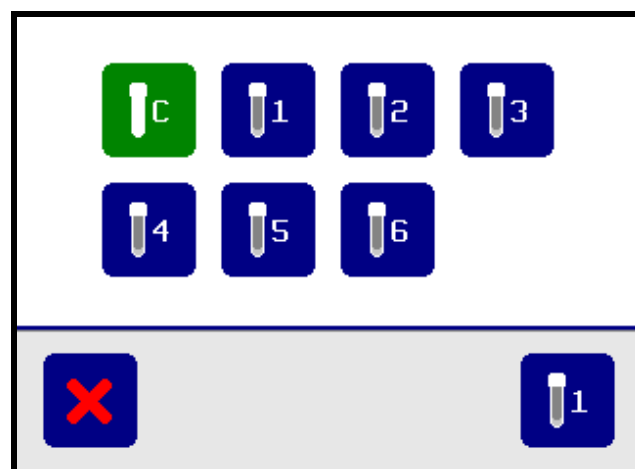

This show that the **Control** tube has been measured and that **Sample 1 to 6** are still to be tested. Press the appropriate tube number (i.e. **1, 2, 3, 4, 5** or **6**) to select that tube to be measured next, or the **Cancel** button to return to the **Protocol** selection screen.

The **Test** screen then prompts for the specific tube number for be inserted, or press the **Tube Select** button the select a different tube number.

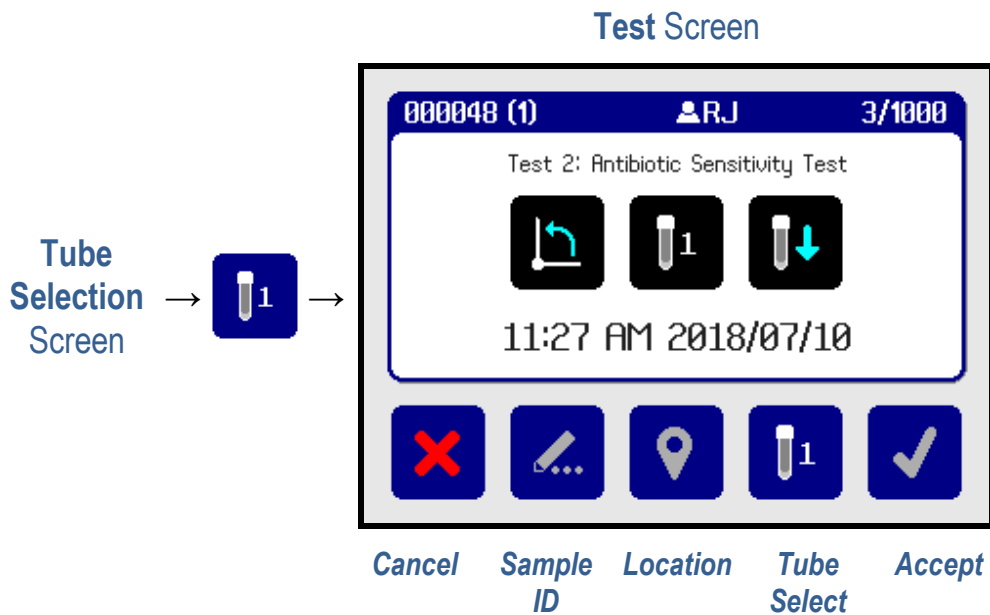

Once two or more tubes have been measured, the result is displayed as a comparative bar chart.

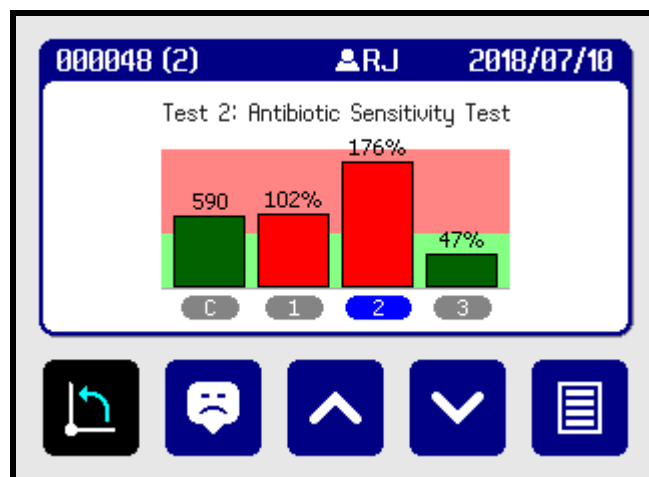

Refer to Section 7.7.4 for details of how the define the **Comparison Band** limits.

7.7.2.3 Continuing a Multi-Tube Test from the Worklist

For a multi-tube test, it may be necessary to perform the **Control** reading and then return some time later to perform the related **Sample** tube measurement.

This is achieved by pressing the **Worklist** button on the Protocol screen to display and select any *unfinished* tests.

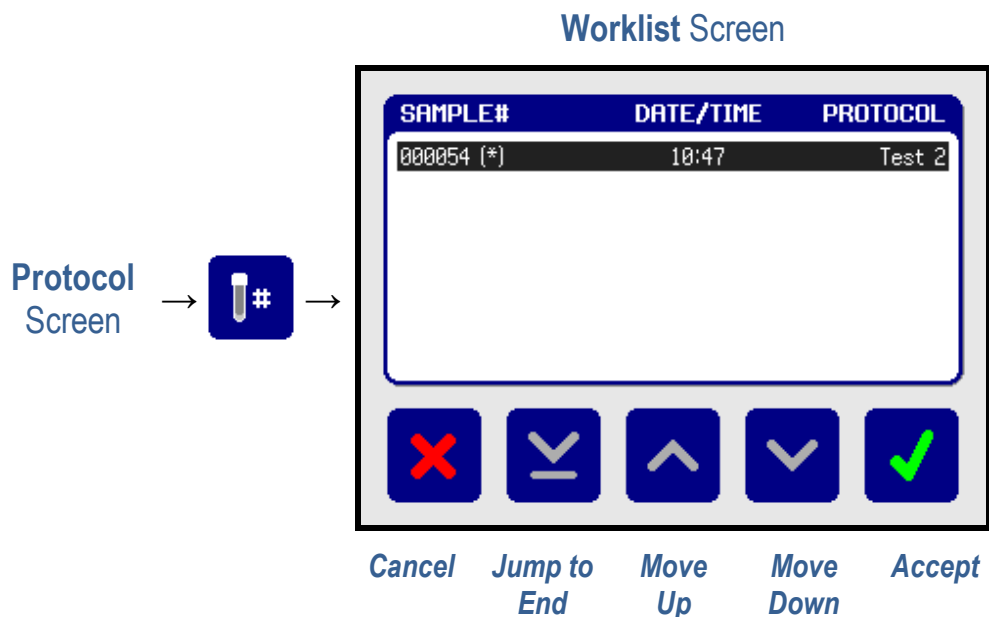

Highlight the sample test from the list then press the **Accept** button to continue with that test, or the **Cancel** button to return to the Protocol selection screen.

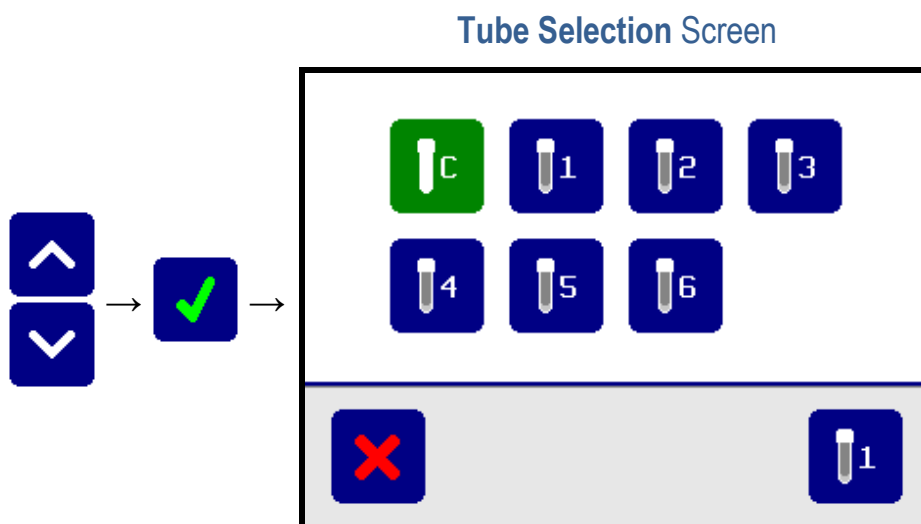

7.7.3 Measurement Types

The next group of Protocol definition fields relates to how the sample is measured by the Lu-mini Unit to produce a test result value.

When the Lu-mini unit measures a test sample, it performs the following steps, as defined by the selected Protocol:

- 1** Acquire measurement data
 - Optional: Pre-zero phase ⇒ *Below*
 - Open internal shutter
 - Initial 10-second reading
 - Optional: Additional 1 to 300-second data collection ⇒ *Below*
 - Close internal shutter
- 2** Translate reading data according to Assay curve ⇒ 7.8
- 3** Process reading data (as per Protocol definition) ⇒ *Below*
- 4** Calculate final test result ⇒ 7.7.4

Hence the measurement sequence is:

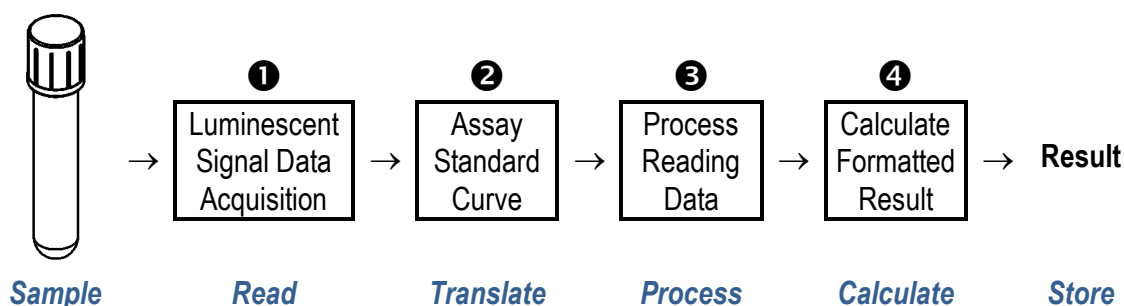

The measurement parameters are:

Measurement Type	Sample measurement type
Show Graph	Show data progress graph for long measurement times
T1	Result analysis time t1 in seconds
T2	Result analysis time t2 in seconds
Window	Result analysis window size in seconds
Threshold	Percentage change threshold limit

The **Measurement Type** (specified in Table 20) defines how measurement data is acquired and processed by the Lu-mini unit:

Table 22: Sample Measurement Types	
Standard	Simple reading with additional averaging window (T2)
Dual Point (T2-T1)	Difference Reading between readings at T1 and T2
Reaction Rate	As Dual Point but result expressed as <i>per second</i>
Peak Detect	Peak detection Between T1 and T2, with window average and detection threshold

The **Measurement Type** determines the purpose of the other measurement parameters:

Measurement Type	T1 (seconds)	T2 (seconds)	Window (seconds)	Threshold (%)
Standard	Averaging Window Start	Averaging Window End	-	-
Dual Point (T2-T1)	Start Time	Maximum Time	-	-
Reaction Rate	Start Time	Maximum Time	-	-
Peak Detect	Start Time	Maximum Time	Averaging Window	Percentage Drop

The **Show Graph** option is mainly intended for use when developing a new Protocol so that the reaction data can be observed in real time. Then, once the protocol parameters have been finalised, the option can be set to **No** to hide the graph from the normal user.

7.7.4 Test Result Options and Banding

Once the final test result value has been calculated by the Lu-mini Unit, there are two further steps that determine how the result is displayed on the unit.

The first set of options control how the displayed result is formatted:

Result DPs	Number of decimal-places displayed (0 to 3)
Result Units	Units of measurement (e.g. RLUs)

The **Result DPs** is intended to be used in conjunction with the **Scaling Factor** (Section 7.7.1) to convert a reading to specific **Result Units** of measurement.

The second set of options control how the result is qualified:

Lock Status	Prevent user from changing pre-assigned Status value
Result Banding	Qualify result using individual Banding limits
Limit Result	Limit result value to within overall Banding limits
Comparison Bands	⇒ Refer to Section 7.7.2
Show Relative	⇒ Refer to Section 7.7.2

Double clicking on (or **Editing**) either the **Result Banding** or **Comparison Bands** fields opens the following configuration window.

Test 2: UTI Antibiotic Sensitivity Test

Result Banding: "Single Sample" and "Control" Test Results

Band	Lower Limit	Text	Colour	Status
1	0	NEGATIVE	GREEN	Good
2	3200	POSITIVE	RED	Bad
3				
4				
5				
6				

Limit Result
 Unlimited Range



Comparison Bands: Multi-Sample Test Results (as a percentage of "Control" Test Result):

Band	Percentage	Text	Colour	Status
1	0	SENSITIVE	GREEN	Good
2	75	RESISTANT	RED	Bad
3				
4				

Relative Result
 Relative: -100% to -25%

Lock Result Status

For **Single Sample** and **Control** sample readings, the quantitative result value can be qualified by checking it against up to six **Result Bands**. For instance, the above example translates as:

$0 \text{ RLU} \leq \text{Result} < 3200 \text{ RLU}$	NEGATIVE	
$3200 \text{ RLU} \leq \text{Result}$	POSITIVE	

Ticking the **Limit Result** check box would restrict the test result value to within the minimum and maximum bands limits of 0 to 3200 RLU.

Ticking the **Lock Result Status** check box prevents the unit user from changing the result **Status** tag (see Section 6.4.5). On the Lu-mini unit Result screen this is displayed as:

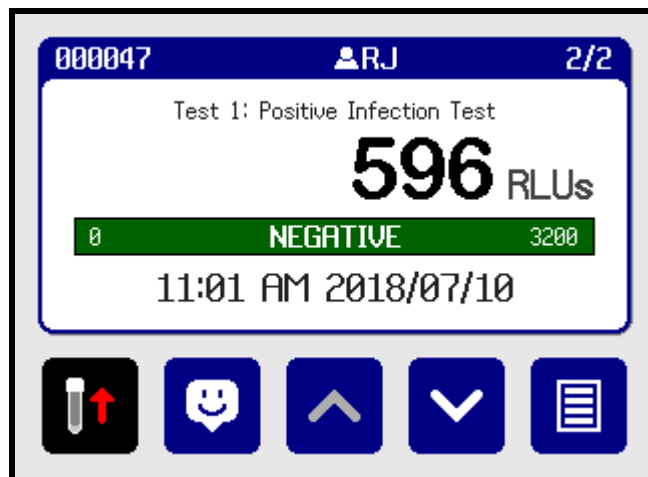

For multiple sample tests (**Control + 1 Sample** thru **Control + 6 Samples**) the **Sample** readings can be compared against **Control** reading and qualified by checking it against up to four **Comparison Bands**. For instance, the previous example above translates as:

$$\text{Percent Result} = \frac{\text{Sample reading}}{\text{Control reading}} \quad (\text{Relative Result} = \text{Percent Result} - 100\%)$$

$0\% \leq \text{Percent Result} < 75\%$	SENSITIVE		$(-100\% \leq \text{Relative Result} < -25\%)$
---	------------------	---	--

$75\% \leq \text{Percent Result}$	RESISTANT		$(-25\% \leq \text{Relative Result})$
-----------------------------------	------------------	---	---------------------------------------

Ticking the **Relative Result** check box displays the result as a relative percentage (with respect to the Control sample reading).

On the Lu-mini unit Result screen this is displayed as:

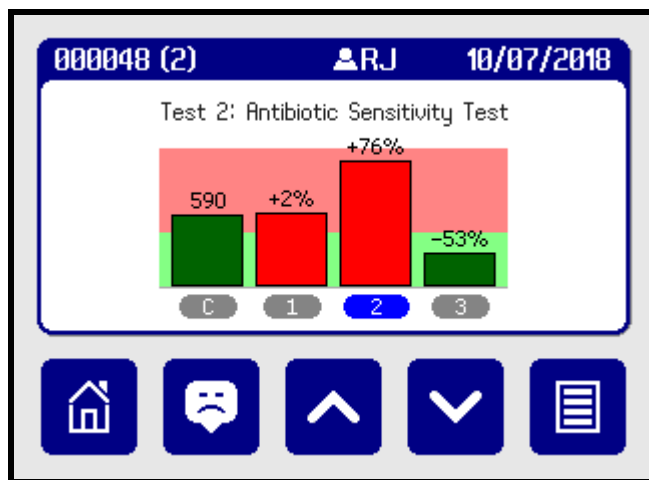

7.8 Reagent Assays Page

The **Reagent Assay** table allows standardised assays to be defined. In general, one assay will be used by several Protocols with different measurement and result parameters.

To create a new Assay, click the toolbar **Add** button and then enter all the appropriate data field values.

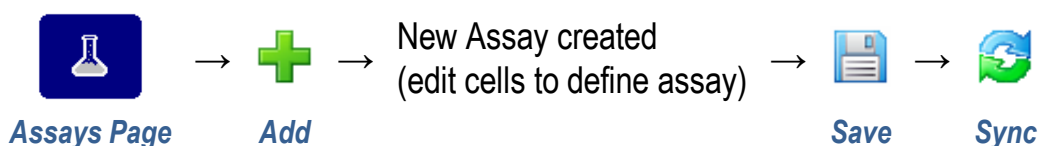

Alternative a copy of an existing Assay can be copied and modified by right-clicking on the existing assay **Line** and then selecting the **Duplicate Line** option from the Context Menu and editing the required data field values.



The available **Reagent Assay** data fields are listed in Table 23 below.

Table 23: Reagent Assay Data Fields		
Assay Name	Unique name of Assay	⇒ 7.7.1
Detection Type	Method of assay output quantitative detection	⇒ 7.8
Curve X-Data	Standard calibration curve x-axis data	⇒ 7.8
Curve Y-Data	Standard calibration curve y-axis data	⇒ 7.8
Curve Fit	Curve fit method	⇒ 7.8
Notes	Optional: Additional notes	⇒ 7.2.4

The **Assay Name** is the unique name used to identify and select the Assay in the associated Protocols (see Section 7.7.1).

The **Detection Type** defines the quantitative method of detection used by the assay. Currently the Lu-mini only supports **Luminescence**, but future versions will support alternative methods.

The remainder of the parameter fields allows a standard calibration curve to be implemented. Clicking on either of the **Curve X-Data**, **Curve Y-Data** or **Curve Fit** fields opens the following definition window.

Assay Data Definition - ATP Type 1

Standard Curve Data Set:

N	X: RLU	Y: Reading
1	0	0.000
2	3260	550.000
3	12860	1450.000
4	17720	2350.000
5	22090	3640.000
6	25680	5210.000
7	31050	8930.000
8	35150	13450.000
9	39160	20080.000
10		

Delete Point
Insert Point

Data Fit Method: Linear Interpolation ▾

OK
Cancel

This provides a transfer function between **Standard Lu-mini RLUs** (input) and the required **Assay Reading** (output).

Currently the only **Data Fit Method** available is **Linear Interpolation** between the data points (with Linear Extrapolation at the extremes).

8 Troubleshooting

For technical enquiries, please contact your distributor or Vitl at the address given on page 2 of this manual.

Table 24: Troubleshooting Suggestions

Unit will not turn on	
• No power → <i>Check power is switched on at wall outlet socket</i>	⇒ 6.2
• Bad USB connection → <i>Ensure power connector fully inserted into rear of unit</i>	⇒ 6.2
Unit spuriously resets or restarts automatically	
• Power connector loose → <i>Ensure USB connector fully inserted at rear of unit</i>	⇒ 6.2
• Bad USB cable → <i>Use good quality USB 2.0 cable, as supplied with the unit</i>	⇒ 6.2
• Supply brown-outs or black-outs → <i>Power unit from a stable AC mains supply</i>	⇒ 11
Unit does not recognise sample tube insertion	
• Tube too small → <i>Ensure minimum tube requirements met</i>	⇒ 4.1
Measurement result lower than expected	
• Tube poorly inserted → <i>Ensure tube is pushed fully down in tube holder</i>	⇒ 4.1
• Low sample volume → <i>Ensure sample greater than minimum operating volume</i>	⇒ 4.1
• Wrong protocol selected → <i>Ensure using correct measurement protocol</i>	⇒ 6.4
• Dirty chamber → <i>Check that dirt not built up in sample measurement chamber</i>	⇒ 9.1
Measurement result higher than expected	
• Wrong protocol selected → <i>Ensure using correct measurement protocol</i>	⇒ 6.4
• Light ingress → <i>Do not use unit in direct sunshine or under infrared lighting</i>	⇒ 5
Lu-mini App reports No Units Attached	
• USB Driver → <i>Ensure that the USB Driver is installed</i>	⇒ 7.1

If the software detects a problem with the unit, it displays the following error popup showing one of the error codes listed in Table 25.

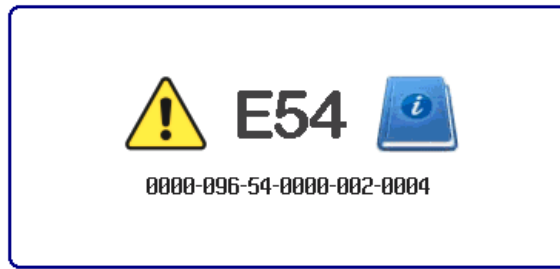



If the problem persists, please contact your distributor or Vitl for assistance, quoting the error code and the 20-digit report code. A copy of the unit screen image can be captured using the **Capture Unit Screenshot** option in the Lu-mini App **Help** menu (see Section 7.2.3).

Code	Meaning	Suggested Remedy
E10	User Preferences not set	Review option settings and adjust as required ⇒ 6.7
E86	Real-Time Clock battery flat	Leave the unit plugged in for at least two hours to recharge clock battery ⇒ 6.7.1
All others	Internal unit fault	Contact distributor for further assistance ⇒ 10

9 Maintenance and Servicing

Although the Lu-mini unit does not require any scheduled servicing, the operator should regularly clean and inspect the unit for defects, as described in Section 9.1 below.

 DANGER	Please observe and comply with all of the Unit Maintenance and Serviceability safety precautions listed in Section 2.
 WARNING	Always unplug the unit before performing any cleaning or disinfecting tasks.
 CAUTION	Never remove the unit casework. There are no user or operator serviceable parts inside the unit.
	Never use alcohol-based cleaners on the black surfaces inside the lid as it will remove the coating and significantly degrade the unit's performance.
	Practise anti-static precautions by avoiding directly touching the exposed electrical contacts or using statically charged cleaning cloths.

For technical and service related enquiries, please contact your distributor or Vitl at the address given on page 2 of this manual.

9.1 Routine Cleaning and Inspection

The unit casework should be cleaned and inspected at regular intervals, and whenever contamination or spillage occurs, as follows:

1. Disconnect the USB power cord from the unit before performing any inspection checks or cleaning.
2. Wearing suitable PPE, clean the casework using a damp cloth or cotton bud soaked with a suitable disinfectant solution (such as Virkon). Do not over wet.
3. Clean around the LCD fascia and touchscreen, taking care to avoid over wetting or pushing debris into the bezel gap.
4. Clean inside the lid, taking particular care not to rub away the black coating.

5. If necessary, carefully clean the sample chamber using a damp long-stick cotton bud only. Do not push anything else into the cavity as it may get caught on the tube alignment string and damage the unit.

**WARNING**

After cleaning, ensure that the unit is thoroughly dry before reconnecting the power cord to the unit.

9.2 Decontamination Procedure

The unit and accessories should be decontaminated using the following procedure before being stored or transported.

Certificate of Decontamination

We respect the health and safety of our clients and employees, and request that any products or accessories being returned are decontaminated in accordance with the procedure below.

1. Decontamination Procedure

Thoroughly clean all outside surfaces of the product (including any accessories, power cords, manuals, packaging, etc) with a damp cloth soaked with suitable disinfectant solution (such as Virkon).

Allow to dry fully before packing.

2. Decontamination Declaration

Company Name: _____

Address: _____

Product Code: Lu-mini

Serial Number: _____

Reason For Return: _____

Where Product Used: _____

Please tick the appropriate option(s) below:

- I certify that I have decontaminated the product as per the above procedure.
 Decontaminant Used: _____
- I certify that the product has not been exposed to any chemical or biological materials.

Title: _____ Name: _____

Signature: _____ Date: _____

Telephone: _____ Email: _____

9.3 Transportation and Storage

The Lu-mini unit and its accessories should be thoroughly decontaminated using the procedure detailed in Section 9.2 before being placed in its original packaging for transportation or storage.

 WARNING	<p>Refer to Section 11 for the acceptable range of Storage and Transportation environmental conditions.</p> <p>Always ensure that the unit and accessories are completely dry and free of any condensation before being packed.</p>
---	---

9.4 Product Disposal

At end-of-life, this product must be disposed of in accordance with your local authority regulations for the disposal of potentially hazardous waste and electronic equipment.

The unit and its accessories should be decontaminated using the procedure detailed in Section 9.2 before disposal or shipping.

	<p>Do not dispose of this product into unsorted municipal waste or public landfill.</p>
---	---

Please contact your distributor (or Vitl at the address on page 2 of this manual) for details of how to correctly dispose of this product.

China RoHS		This table has been prepared in accordance with SJ/T 11364 此表格表明符合SJ/T 11364标准					
Part Name 部件名称	Toxic and Hazardous Substances and Elements 有毒有害物质或元素						
	Pb 铅	Hg 汞	Cd 镉	Cr6 六价铬	PBB 多溴联苯	PBDE 多溴二苯醚	EFUP 环保使用期限
CASEWORK	O	O	O	O	O	O	e
CONTROL PCB	X	O	O	O	O	O	50
READER MODULE	X	O	O	O	O	O	25
TUBE DETECTOR CABLE	O	O	O	O	O	O	e
	EFUP No (Overall) 环保使用期限						
O: Indicates that the part contains hazardous a substance below the level listed in GB/T 26572 表示料件所包含有害物质低于在GB/T 26572中列出的标准。							
X: Indicates that the part contains hazardous a substance above the level listed in GB/T 26572 表示料件所包含有害物质超过在GB/T 26572中列出的标准。							

10 Warranty and Returns

Integrated Technologies Limited (ITL) warrants the Lu-mini product, when purchased new and installed and operated in accordance with the instructions of this manual, to be free from defects in materials and workmanship, and will repair or replace, at their discretion, any unit or accessory which exhibits such defects.

In no event will ITL be liable for any indirect, incidental or consequential damages resulting from any defect or warranty claim.

**NOTE**

Unspecified use or unauthorised modification of any part of the Lu-mini unit or its accessories or the use or attachment of any adaptor or peripheral not supplied, specified or sanctioned by ITL will invalidate this warranty.

This warranty is provided to the original purchaser of the product for one year from the date of purchase.

Under the terms of this warranty, the product must be returned in its original packaging, transportation prepaid by the sender, with a copy of the Proof of Purchase and a detailed description of the problem.

**WARNING**

The product must be decontaminated using the procedure detailed in Section 9.2 and a Certificate of Decontamination supplied with any return. If the product is considered too hazardous to be shipped, please contact Vitl on the number given on page 2 of this manual for further instructions.

Please contact your distributor (or Vitl on the number given on page 2 of this manual) to receive authorisation to return the product.

11 Technical Specification

Physical Unit Properties

Dimensions (W x D x H)	160 mm x 235 mm x 140 mm
Weight	1.9 kg

Power Supply

Power Adaptor Input Voltage	100 to 240V AC $\pm 10\%$, 50/60 Hz $\pm 5\%$
Power Adaptor Consumption	25W max
Power Adaptor Output	5.0V DC $\pm 5\%$, 1.0A max
Unit Input Voltage and Current	USB-B: 5.0V DC $\pm 5\%$, 1.0A max

Operating Environment

Temperature Range	+15 to +35 °C
Relative Humidity Range	20% to 85% non-condensing
Maximum Operating Altitude	2000 m above sea-level

Storage and Transportation

Temperature Range	-10 to +50 °C
Relative Humidity Range	20% to 95% non-condensing

Sample Tube Types

Round Bottomed Tubes	10-15mm diameter, 47-75mm tall
Flat Bottomed Vials	15mm diameter, 48mm tall
Square Cuvettes	12.5mm square, 45mm tall
Minimum Sample Volume	Refer to Table 4

Measurement Range

Standard RLU Protocol	0 to 8×10^6 RLU
-----------------------	--------------------------

Unit Data Storage Capacity

Users	50
Test Protocols	100
Test Results	1000 (or up to 30000 seconds of Kinetic Data)

Lu-mini App Storage Capacity

Users	Unlimited (50 Active)
User ID Length	1 to 4 characters
User Name Length	20 characters
User Password Length	20 characters
Test Protocols	Unlimited (100 Active)
Protocol Name Length	1 to 12 characters
Protocol Description Length	1 to 50 characters
Test Results	Unlimited
Result Decimal Places	3 maximum
Units of Measurement	1 to 7 characters
Test Result Bands	
Band Name	1 to 12 characters
Result Bands	6 maximum
Comparison Bands	4 maximum
Comparison Range	0 to 10000%
Test Assays	Unlimited
Assay Name	1 to 20 characters
Assay Curve Points	10 maximum

12 Glossary of Terms and Abbreviations

ANSI	American National Standards Institute
EMC	Electro-Magnetic Compatibility
Incubate	Keeping an organism, cell or cell culture at the optimum temperature for growth and development
PCR	Polymerase Chain Reaction
Pellet	A small densely packed mass. Created, for example, via the centrifugation of a suspension
PPE	Personal Protective Equipment
RLU	Relative Light Units. An arbitrary unit of light measurement
SBS	Society for Biomolecular Screening